



REQUEST FOR PROPOSALS FOR THE

**Collection and Transportation of Residential Waste and
Organics (Compostables) for the
Eastern Kings Region
For
Island Waste Management Corporation**

Request for Proposal Number:

RFP # 6055

Date Issued:

May 1st, 2023

Submission Deadline:

Prior to 2 PM, June 13th, 2023

Tables of Contents

PART 1 – INVITATION AND SUBMISSION INSTRUCTIONS	1
1.01 Invitation to Proponents	1
1.02 RFP Contact	1
1.03 Type of Contract for Deliverables	1
1.04 RFP Timetable	2
1.05 Information Provided by IWMC	2
1.06 Submission of Proposals	3
1.07 Amendment of Proposals Prior to Submission Deadline	4
1.08 Withdrawal of Proposals.....	4
1.09 Proposals Irrevocable after Submission Deadline	4
1.10 Receipt of complete RFP	4
1.11 Inquiries	4
1.12 Proponents to review RFP.....	5
1.13 Electronic communication	5
1.14 Addenda	6
1.15 Verify and Clarify.....	6
1.16 Bid security.....	6
1.17 Contract Security.....	7
1.18 Insurance.....	8
PART 2 – EVALUATION OF PROPOSALS	9
2.01 Stages of Evaluation.....	9
2.02 Evaluation of Proposals - General.....	9
2.03 Stage I - Mandatory Submission Requirements.....	10
2.04 Stage II – The Technical Proposal – Submission Pass/Fail Requirements and Evaluation.....	11
2.05 Stage III – The Cost Proposal – Submission Pass/Fail Requirements and Evaluation.....	12
2.06 Stage IV – Compilation of Scores	13
2.07 Stage V - Selection of Highest Scoring Proponent	13
2.08 Notification to Other Proponents	13
PART 3 – TERMS AND CONDITIONS OF THE RFP PROCESS.....	14
3.01 General Information and Instructions	14
3.02 Execution of Agreement, Notification and Debriefing.....	15

3.03	Conflict of Interest and Prohibited Conduct	16
3.04	Confidential Information	17
3.05	Reserved Rights, Limitation of Liability and Governing Law	18

APPENDICIES

APPENDIX A - RFP PARTICULARS

Table A1 - Summary of Residential Collection Programs

Table A2 - Waste Tonnages

Table A3 - Organics Tonnages

APPENDIX B - GENERAL PROPOSAL SUBMISSION FORM AND REQUIREMENTS

APPENDIX C - AGREEMENT

Schedule C - Monthly Payment Amount

Table A4 - Monthly Payment Calculation & Table

Schedule D - Monthly Diesel Fuel Amount Table

Schedule E - Privacy Protection Schedule

Appendix A1 – Contractor’s Pricing

SCHEDULES

Schedule A - Cost Proposal Submission Form (Eastern Kings Region)

Schedule B - Work Specification

Appendix B1 - Collection Vehicle Inspection Report

Appendix B2 - Daily Driver's Report

ATTACHMENTS

Attachment 1 - Collection Map and Schedules

Attachment 2 - IWMC Sorting Guide

Attachment 3 - Apartments List

Attachment 4 - Cart Lifter (Sample)

Attachment 5 - Spring and Fall Cleanup Guidelines

Attachment 6 - Backyard Collections

Attachment 7 - Church Properties

PART 1 – INVITATION AND SUBMISSION INSTRUCTIONS

1.01 Invitation to Proponents

This Request for Proposals (the “RFP”) is an invitation by Island Waste Management Corporation (“IWMC”), a provincial Crown Corporation that administers solid waste management services and programs for Prince Edward Island. IWMC invites qualified Proponents to submit proposals for the Collection and Transportation of Residential Waste and Organics from the Eastern Kings Region, as further described in the RFP Particulars (Appendix A) (the “**Deliverables**”).

Specifically, IWMC is seeking the services for curbside collection and transportation of waste (black carts) and organics (green carts) to the appropriate disposal facility from all residential properties located in the Eastern Kings Region. Residential properties include residential homes of all types, including apartments, condominiums, cottages, and some church properties. Residential properties are provided with 240 or 140 Litre waste and compost carts by IWMC. The manufacturers of the carts are presently either SSI Schaefer or IPL carts. Collection is provided weekly, alternating between waste and compost as per IWMC’s Collection Schedule (Attachment 1 – Collection Maps and Schedules).

IWMC’s Waste Watch program requires residential customers to sort materials in accordance with the IWMC Sorting Guide (Attachment 2- IWMC Sorting Guide).

1.02 RFP Contact

For this process, the “RFP Contact” shall be:

Karen MacDonald
Chief Executive Officer
Island Waste Management Corporation
kmacdonald@iwmc.pe.ca

Proponents and their representatives are not permitted to contact any employees, officers, agents, elected or appointed officials or other representatives of IWMC or the Province of Prince Edward Island, other than the RFP Contact or their designate, concerning this RFP. Failure to adhere to this rule may result in the disqualification of the Proponent and the rejection of the Proponent’s proposal, at the sole discretion of IWMC.

1.03 Type of Contract for Deliverables

The selected Proponent will be required to enter into an agreement with IWMC for the provision of the Deliverables substantially in the form attached as Appendix C to the RFP (the “Agreement”). The initial term of the agreement will be for a period of five (5) years. IWMC reserves the right to extend the agreement for a further three (3) years and then a further two (2) years beyond the initial term, for a potential maximum of ten (10) years in total, under such terms and conditions as set out in this Request.

For each year of an Extension Term(s), IWMC shall adjust all Prices in Schedule A (Cost Proposal Submission Form) of the Agreement by seventy five (75%) of the percentage change (to the nearest one hundredth) in the Consumer Price Index (all items), for Canada as published by Statistics Canada for

each 12-month period immediately preceding the commencement of the next year of the Extension Term(s).

1.04 RFP Timetable

Issue Date of RFP	May 1 st , 2023
Deadline for Questions	May 24 th , 2023
Deadline for Issuing Addenda	June 6 th , 2023
Submission Deadline	June 13th, 2023 prior to 2 PM Atlantic Time
Anticipated Execution of Agreement	August 1 st , 2023

***This timetable is tentative only and may be adjusted by IWMC at any time.**

1.05 Information Provided by IWMC

For this RFP, the region to be collected is the Eastern Kings Region. IWMC has provided map for the Region as an attachment to this RFP. Proponents are responsible for ensuring that they are completely familiar with the Region for which a proposal is submitted. The Eastern Kings Region includes residences in zones A, A1, A2, B, B1, D and D1 on the collection map. Refer to the map attached (Attachment #1) for details and scheduled collection days.

In the RFP Particulars, (Appendix A) attached to this RFP, IWMC has provided the initial estimated number of Serviced Units within the Region, as well as the fiscal year (i.e., April 1 to March 31) reports for Waste and Compost tonnages, for the year from April 2021 to March 2022.

For this tonnage information, Proponents are advised that the monthly tonnages in the Region are estimates. Furthermore, Proponents are advised that the reported tonnage amounts in material streams will vary from week to week, month to month, and year to year, and are influenced by several factors including, but not limited to, seasonality, weather, availability of diversion programs (e.g., stewardship programs), and the list of materials banned from disposal by Provincial regulation.

IWMC does not represent or warrant the adequacy, accuracy or completeness of any information set out in the RFP, including the information referenced above in this Section 1.05, prepared by or on behalf of IWMC or by third parties, which may be made available to Proponents by or through IWMC. Proponents should make such independent assessments as they consider necessary to verify and confirm the adequacy, accuracy and completeness of all such information. Any use of or reliance by Proponents on any and all such information will be at the Proponents' sole risk and without recourse against IWMC.

Each Proponent is solely responsible, at its own cost and expense, to carry out its own independent research, due diligence and to perform such other investigations, including seeking independent advice, considered necessary by the Proponent to familiarize itself with, and satisfy itself in all regards, as to all existing conditions affecting the work to be performed as requested in this RFP.

1.06 Submission of Proposals

1.06.1 Proposals to be submitted at the Prescribed Location

Proposals must be submitted at:

IWMC E-MAIL ADDRESS ONLY

tenders@iwmc.pe.ca

1.06.2 Proposals to be submitted on Time

Proposals must be submitted and received at the email address set out above prior to the Submission Deadline as indicated in section 1.04. The Proponent is solely responsible for the submission of its proposal to the exact e-mail location indicated in this RFP on or before the Submission Deadline. IWMC does not accept any responsibility for proposals e-mailed to any other e-mail location by the Proponent or its delivery agents. Proposals submitted after the Submission Deadline will be rejected. IWMC's time clock at tenders@iwmc.pe.ca will be deemed to be correct. Upon receipt, IWMC will provide a return email to the Proponent to confirm receipt and time.

1.06.3 Proposals to be submitted in Prescribed Format

Submitted proposals must contain the following:

1. One (1) electronic copy of the Technical Proposal saved as a Portable Document Format (PDF). The Technical proposal should be prominently marked as "Technical Proposal" with the RFP title and number (see RFP cover) and the full legal name of the Proponent.

Technical Proposals should comprise:

- a) completed Appendix B – General Proposal Submission Form and Requirements,
 - b) completed response to Appendix A – RFP Particulars, and
 - c) other mandatory submission requirements, as applicable. Cost Proposal information is not to be included in the Technical Proposal.
2. One (1) electronic copy of the Cost Proposal (completed response to Schedule A – Cost Proposal Submission Form) saved as a PDF. The Cost proposal must be emailed as a separate PDF file from the Technical Proposal but can be sent in the same email message.

The Cost Proposal should be prominently marked as "Cost Proposal" with the RFP title and number (see RFP cover) and the full legal name of the Proponent.

Unless specifically requested in this solicitation document, Proponents should not submit product catalogues or other marketing materials with their proposal.

Proposals submitted by **facsimile transfer, courier, mail, hand delivery or any means, other than by email as set out in Section 1.06.1 shall not be accepted.**

IWMC reserves the right to require Financial Statements of the Proponent in order to assess whether the Proponent has sufficient financial capability and resources to perform the work in accordance with the requirements of this RFP and the terms and conditions of the Agreement.

1.07 Amendment of Proposals Prior to Submission Deadline

Proponents may amend their proposals prior to the Submission Deadline by submitting the amendment by e-mail to tenders@iwmc.pe.ca prominently including in the subject line the word “Amendment” with the RFP title and number, and the full legal name of the Proponent. An amendment must clearly indicate which part of the proposal the amendment is intended to amend or replace. Amendments received after the Submission Deadline will not be accepted. Amendments must be signed by the person who signed the original proposal submission or by a person authorized to sign on their behalf.

1.08 Withdrawal of Proposals

Proponents may withdraw their proposal prior to the Submission Deadline. To withdraw a proposal, a notice of withdrawal must be received by the RFP Contact by e-mail prior to the Submission Deadline and must be signed by the person who signed the original proposal submission or by a person authorized to sign on their behalf. IWMC is under no obligation to return withdrawn proposals.

1.09 Proposals Irrevocable after Submission Deadline

Proposals shall be irrevocable for a period of 140 days (20 weeks) from the Submission Deadline.

1.10 Receipt of complete RFP

Proponents are responsible to ensure that they have received the complete RFP. IWMC accepts no responsibility for any Proponent lacking any portion of this RFP.

1.11 Inquiries

All inquiries should be submitted in accordance with the following process as early as possible to permit consideration by IWMC, and in any event no later than as specified in Section 1.04.

All inquiries regarding any aspect of this RFP must be directed to the RFP Contact. The following will apply to any inquiry:

- a) any response from IWMC will be in writing and provided to Proponents, subject to the balance of this Section 1.11;
- b) inquiries to, and responses from, the RFP Contact will be recorded and maintained by IWMC;
- c) any inquiry and the response may, in IWMC’s sole discretion, be distributed to all Proponents if IWMC considers the matter to be one that should be brought to the attention of all Proponents

for purposes of fairness in, or maintaining the integrity of, the competitive selection process. IWMC may keep either or both the inquiry and the response confidential if, in the judgment of IWMC, it is fair or appropriate to do so; and

- d) IWMC may, in its discretion, decline to respond to an inquiry.

Information offered from sources other than the RFP Contact with regard to this RFP is not official, may not be accurate, and should not be relied on by a Proponent for any purpose.

1.12 Proponents to review RFP

Proponents shall promptly examine all of the documents comprising within this RFP and must:

- a) report any errors, omissions or ambiguities; and
- b) direct questions or seek additional information in writing.

Proponents must use the inquiries process set forth in Section 1.11, to the RFP Contact on or before the deadline noted in Section 1.04.

IWMC is under no obligation to provide additional information, and IWMC shall not be responsible for any information provided by or obtained from any source other than the RFP Contact. It is the responsibility of the Proponent to seek clarification from the RFP Contact on any matter it considers unclear. IWMC is not responsible for any misunderstanding on the part of the Proponent concerning this RFP or its process.

1.13 Electronic communication

Proponents must only communicate with the RFP Contact with respect to this RFP.

The following provisions will apply to any communications with the RFP Contact or to the delivery of documents to the RFP Contact where such communications or deliveries are permitted by the terms of this RFP:

- a) IWMC does not assume any risk or responsibility or liability whatsoever to any Proponent:
 - i. for ensuring that any electronic system being operated by or for IWMC, such as e-mail, is in good working order, able to receive transmissions, or not engaged in receiving other transmissions such that a Proponent's transmission cannot be received; or
 - ii. if a permitted communication or delivery is not received by IWMC, or received in less than its entirety, within any time limit specified by this RFP; and
- b) all permitted communications with, or delivery of documents to, the RFP Contact will be deemed as having been received by the RFP Contact on the dates and times indicated on the RFP Contact's email system.

1.14 Addenda

This RFP may be amended only by Addendum in accordance with this section.

If IWMC, for any reason, determines that it is necessary to provide additional information relating to this RFP, such information will be communicated by written addendum posted on the PEI Government Tendering Page and IWMC's website. Only the RFP Contact is authorized to amend or clarify this RFP by issuing an Addendum. No other employee or agent of IWMC is authorized to amend or clarify this RFP.

Written addenda are the only means of amending or clarifying this RFP, and no other form of communication whether written or oral, including written responses to inquiries as provided by Section 1.11, will be included in, or in any way amend, this RFP.

Each addendum forms an integral part of this RFP and may contain important information, including significant changes to this RFP. Proponents are responsible for obtaining all addenda issued by IWMC.

If IWMC determines that it is necessary to issue an addendum after the deadlines noted in Section 1.04, IWMC may extend the deadlines for a period of time considered reasonable and appropriate by IWMC.

1.15 Verify and Clarify

During the evaluation process, IWMC may request further information from a Proponent or third parties in order to verify or clarify the information provided in the Proponent/s proposal, including but not limited to clarification with respect to whether a proposal meets the mandatory technical requirements set out in the RFP. IWMC may revisit and re-evaluate a Proponent's response or ranking on the basis of any such information.

1.16 Bid security

1.16.1 Proponent's Bid Security

For the purposes of this RFP, the Proponent's Bid Security means a bid bond, demand bond, irrevocable letter of credit, or other form of bid security acceptable to IWMC, in the amount of \$20,000 (CDN). A Proponent must include its Bid Security with its proposal submission, but as a separate attachment.

The Proponent's Bid Security must:

- a) be submitted in an original, electronic format and must be viewable, printable and storable by IWMC. PDF scans or other reproductions of the Bid Security are not acceptable;
- b) be verifiable by IWMC with the issuer of the Bid Security with respect to the totality and wholeness of the form of the Bid Security, including, but not limited to: (a) the content; (b) all digital signatures; and (c) all digital seals;
- c) for any bond used as Bid Security, name "Island Waste Management Corporation" as the Obligee and such bond shall be signed, sealed, and dated by both the Proponent and the surety provider;

- d) for any bond used as Bid Security, be verifiable by IWMC immediately, or at any time during the life of the bond, with no requirement for passwords or fees and the results of such verification must provide a clear, immediate, and printable indication of the verification's success or failure.

All costs of purchasing and administration for the Proponent's Bid Security shall be at the expense of the Proponent. Proponents shall secure the Proponent's Bid Security from financially sound surety companies, Schedule I or Schedule II (with IWMC approval) banks or other financially sound providers of security which are licenced to do business in Prince Edward Island, and which have a credit rating of no less than A – with a major credit rating agency.

1.16.2 Return of Proponent's Bid Security

Subject to Section 1.16.3, IWMC will return the Proponent's Bid Security, without interest, to the Proponent within 5 business days after:

- a) IWMC has executed the agreement with the selected Proponent;
- b) IWMC exercises its right in accordance with this RFP to terminate this RFP prior to entering into an agreement with a Proponent, and such termination is for reasons unrelated to the Proponent requesting the return of the Proponent's Bid Security; or
- c) IWMC fails, within the proposals irrevocable submission deadline in Section 1.09, to execute and deliver agreements, provided that such failure is not the result of:
 - i. the failure of the Proponent to satisfy any conditions set out in this RFP or the applicable agreement; or
 - ii. an extension made by IWMC to the Submission Deadline in Section 1.04, arising from the need by IWMC to negotiate changes to the agreement prior to its finalization and execution.

1.16.3 Retention of Proponent's Bid Security

IWMC may, in its discretion, draw on, retain and apply the proceeds of the Proponent's Bid Security for IWMC's own use as liquidated damages, if:

- a) the Proponent is in material breach of any term of this RFP; or
- b) after receipt of written notice from IWMC that the Proponent has been selected to execute the Agreement the Proponent fails to execute and deliver the Agreement, substantially in the form of the agreement set forth in this RFP at Appendix C.

1.17 Contract Security

The successful Proponent shall be required to provide IWMC with a Performance Bond or a performance deposit for the duration of the Term and Extension Term(s), as set out in the Agreement (Appendix C), which requirement shall form part of the Agreement.

1.18 Insurance

The successful Proponent shall be required to have insurance coverage for the duration of the Term and Extension Term(s), as set out in the Agreement (Appendix C).

[End of Part 1]

PART 2 – EVALUATION OF PROPOSALS

2.01 Stages of Evaluation

IWMC will conduct the evaluation of proposals in stages as set forth in this Part 2. IWMC will not evaluate or continue to evaluate a Proposal if it has been rejected or disqualified, in accordance with this RFP.

2.02 Evaluation of Proposals - General

IWMC may, in its sole discretion, take any one or more of the following steps, at any time and from time to time, in connection with the review and evaluation, including ranking, of any aspect of a Proposal, including if IWMC considers that any Proposal, or any part of a Proposal, requires clarification or more complete information, contains defects, alterations, qualifications, omissions, inaccuracies or misstatements, or does not for any reason whatsoever satisfy IWMC that the Proposal meets all the requirements of this RFP at any time, or for any other reason IWMC in its sole discretion deems appropriate and in the interests of IWMC and this RFP, or either of them:

- a) waive any such defect, ambiguity, alteration, qualification, omission, inaccuracy, misstatement or failure to satisfy, and any resulting ineligibility on the part of the Proponent;
- b) correct mathematical errors (unit prices/hourly rates will be assumed correct for each line item and used to quantify the total cost based on the estimated quantities);
- c) independently consider, investigate, research, analyze, request or verify any information or documentation whether or not contained in any Proposal;
- d) request interviews or presentations with any, all or none of the Proponents to clarify any questions or considerations based on the information included in Proposals during the evaluation process, with such interviews or presentations conducted at the discretion of IWMC including the time, location, length and agenda for such interviews or presentations;
- e) conduct reference checks relevant to the work associated with the Proposal with any or all of the references cited in a Proposal and any other persons (including persons other than those listed by Proponents in any part of their Proposals) to verify any and all information regarding a Proponent, inclusive of its directors/officers, and to conduct any background investigations that it considers necessary in the course of the evaluation process, and rely on and consider any relevant information from such references and other persons in the evaluation of Proposals;
- f) conduct any other reference checks (including sources internal to IWMC);
- g) conduct credit, criminal record, litigation, bankruptcy, taxpayer information and other checks;
- h) not proceed to review and evaluate, or discontinue the evaluation of any Proposals, and disqualify the Proponent from this RFP; and
- i) seek clarification from any Proponent in connection with their Proposal.

Without limiting the foregoing or the evaluation process set forth in this Part 2, IWMC may, in its discretion (and without further consultation with the Proponent), reject any Proposal which in the sole opinion of IWMC:

- a) is materially incomplete or irregular;
- b) contains omissions, exceptions or variations, including any modifications, changes or additions to these RFP documents made by the Proponent, not acceptable to IWMC;
- c) contains individual monthly or other unit prices that are obviously unbalanced in that they do not reflect the reasonable actual anticipated costs for the performance of the work items, either excessively above or excessively below the reasonable cost analysis value for the work items;
- d) contains any false or misleading statement, claims or information; or
- e) contains any false statements, criminal affiliations, or activities by a Proponent.

To enable IWMC to take any one or more of the above-listed steps, IWMC may enter into separate and confidential communications of any kind whatsoever, with any person or organization, including any Proponent. IWMC has no obligation whatsoever to take the same steps, or to enter into the same or any communications in respect of all Proponents and Proposals, or in respect of any Proponent, including the Proponent whose Proposal is the subject of the review or evaluation, as the case may be.

The review and evaluation, including the ranking, of any Proposal may rely on, take into account and include any information and documentation, including any clarification, more complete, supplementary and additional or replacement information or documentation, including information and documentation obtained through any of the above-listed investigations, research, analyses, checks, and verifications.

If any information, including information as to experience or capacity, contained in a Proposal is not verified to IWMC's satisfaction, IWMC may, in its discretion, choose to not consider such cited experience, capacity or other information.

IWMC is not bound by industry custom or practice in taking any of the steps listed above, in exercising any of its discretions, in formulating its opinions and considerations, exercising its discretions in making any decisions and determinations, or in discharging its functions under or in connection with this RFP, or in connection with any Proponent, Proposal, or any part of any Proposal.

IWMC is not responsible for identifying all areas in which a Proposal does not meet the requirements of these RFP documents, including the agreement. Irrespective of whether IWMC has identified or has failed to identify any such areas, a Proponent is not relieved in any way from meeting the requirements of this RFP, and, if selected as a successful Proponent, will not be relieved from meeting all requirements of the agreement, including by rectifying any non-compliances (material or otherwise) in its Proposal.

2.03 Stage I - Mandatory Submission Requirements

Stage I will consist of a review to determine that proposals comply with the following Mandatory Submission requirements.

2.03.1 Technical Proposal

The Technical Proposal must be submitted in the manner set forth in Section 1.06.3 of this RFP and received by IWMC no later than the Submission Deadline as set forth in Section 1.04.

2.03.2 Cost Proposal

The Cost Proposal must be submitted in the manner set forth in Section 1.06.3 of this RFP and received by IWMC no later than the Submission Deadline as set forth in Section 1.04.

Proposals that do not comply with all the Mandatory Submission requirements as of the Submission Deadline will be disqualified and not evaluated further.

2.04 Stage II – The Technical Proposal – Submission Pass/Fail Requirements and Evaluation

2.04.1 Pass/Fail Requirements

Technical Proposals will be reviewed to determine whether the following information is included. Failure to include any of the following information in the Technical Proposal will result in the submission being disqualified and not evaluated further. The information required to be included in the Technical Proposal is:

- a) A completed Technical Proposal which addresses the requirements set forth in this RFP, and in particular Appendix A – RFP Particulars;
- b) a completed General Proposal Submission Form and Requirements as set forth in Appendix B to this RFP;
 - i. (Note that the General Proposal Submission Form and Requirements must be completed and signed by an authorized representative of the Proponent. Other than providing the information requested, a Proponent should not make changes to the Form. Any proposal containing such changes, whether on the face of the form or elsewhere in the proposal, may be disqualified.)
- c) the Bid Security, as set forth in Section 1.16 of Part 1 of this RFP;
- d) documentation, reasonably acceptable to IWMC (for example, a signed letter from a chartered bank, surety company or recognized financial institution) evidencing that a chartered bank, surety company or other recognized financial institution has agreed to provide the Proponent with the Performance Security, in the amount and on such terms and conditions as set forth in Section 4.16 of the Agreement (Appendix C), should the Proponent be successful in its bid; and,
- e) documentation, reasonably acceptable to IWMC (for example, a signed letter from the Proponent's insurance company) evidencing that a provider of insurance has agreed to provide the Proponent with the required insurance, in the amounts and on such terms and conditions as set forth in Section 8 of the Agreement (Appendix C), should the Proponent be successful in its bid.

2.04.2 Evaluation of Rated Criteria for the Technical Proposal

Submissions that have met the Pass/Fail Requirements of Section 2.04.1 will be evaluated and scored based on the rated criteria as set out in the following table.

A Technical Proposal must score a minimum of 56 points out of the possible 80 total available points (70%), as well as a minimum of 60% in each of the four rated criteria in order to advance to Stage III.

Rated Criteria¹		Weighting (Points)
Technical Proposal		
1	Proponent Corporate Profile and Reference Experience	20 points
2	Equipment, Maintenance and Sustainability of Collection Fleet	24 points
3	Proponent Team and Customer Service	18 points
4	Collection Plan: Collection Plan and Schedule, Health and Safety and Data Management	18 points
Total Technical Proposal		80 points

2.05 Stage III – The Cost Proposal – Submission Pass/Fail Requirements and Evaluation

2.05.1 Pass/Fail Requirements

Cost Proposals will be reviewed to determine whether the following information is included. Failure to include the following information in the Cost Proposal will result in the submission being disqualified and not evaluated further. The information required to be included in the Cost Proposal Submission is:

- a) A Cost Proposal Submission Form “Working Copy”, and a Cost Proposal Submission Form “Authorized Copy”, completed as per the Requirements set forth in Appendix A – RFP Particulars, Section 2.2.
- b) The Submission Pricing Form must be fully completed by inserting prices for all Work for each of the five years of the Agreement.

2.05.2 Evaluation and Scoring of Cost Proposals

Submissions that have met the Pass/Fail Requirements of Section 2.05.1 will be evaluated and scored as follows:

¹ Appendix A includes details on proposal requirements for rated criteria

a) **Errors and Discrepancies**

For Cost Proposals that contain mathematical errors, unit prices/hourly rates will be assumed correct for each line item and used to extend the estimated quantities to calculate the total cost for the line item.

b) **Alternative Pricing**

Proponents shall provide pricing in the manner set out in the Cost Proposal Submission Form. Alternative pricing or other optional pricing will not be evaluated.

c) **Scoring**

The Cost Proposal with the lowest overall submitted five (5) year cost shall receive 120 points (Maximum Available Points). Other successful Cost Proposals not having the lowest overall submitted cost will be prorated and will be awarded points using the following formula.

Max Available Pts. - $[\text{Max Available Pts.} \times (\text{total cost} - \text{lowest total cost}) / \text{lowest total cost}]$

Note: If the result is a negative number, the score assigned will be 0.

Example: Two compliant bids are received and the maximum available points for cost equal 120:

Bid 1: \$5,000,000

Bid 2: \$5,250,000

Bid 1 being the lowest, would achieve a score of 120 points

Bid 2 would achieve a score of 114 points, calculated as follows:

$120 - [120 \times (\$5,250,000 - \$5,000,000) / \$5,000,000] = 114$

2.06 Stage IV – Compilation of Scores

Following the completion of Stage III, the scores from successful proposals at Stage II and Stage III will be added together to determine an overall score for each Proposal.

2.07 Stage V - Selection of Highest Scoring Proponent

Subject to the terms and conditions applicable to this RFP, including IWMC's right to reject any or all proposals, the Proponent with the highest-scored proposal which also meets the conditions of award will become the Preferred Proponent and selected to enter into the Agreement (Appendix C) in accordance with Part 3. Upon finalization of the Agreement, the Proponent shall thereafter be known as "the Contractor". Notwithstanding the forgoing and for further clarity, IWMC is not bound to enter into an Agreement with the Proponent who submits the lowest priced Proposal or with any Proponent. Proposals will be assessed in light of all evaluation criteria.

2.08 Notification to Other Proponents

Once an Agreement has been finalized and executed by the IWMC with a Contractor, the unsuccessful Proponents will be notified in accordance with the Terms and Conditions of the RFP Process (Part 3).

[End of Part 2]

PART 3 – TERMS AND CONDITIONS OF THE RFP PROCESS

3.01 General Information and Instructions

THE FOLLOWING TERMS AND CONDITIONS ARE IN ADDITION TO ANY TERMS AND CONDITIONS SET FORTH IN PART 1 OR PART 2 OF THIS RFP.

3.01.1 RFP Incorporated into Proposal

All the provisions of this RFP are deemed to be accepted by each Proponent and incorporated into each Proponent's Proposal. A Proponent who submits conditions, options, variations or contingent statements inconsistent or at variance with the terms set out in this RFP, including the terms of the Agreement (Appendix C), either as part of its Proposal or after receiving notice of selection, may be disqualified by IWMC in IWMC's absolute and sole discretion.

3.01.2 Proponents to Follow Instructions

Proponents should structure their Proposals in accordance with the instructions in this RFP. Where information is requested in this RFP, any response made in a Proposal should reference the applicable section numbers of this RFP.

3.01.3 Language

All Proposals are to be in English only.

3.01.4 No Incorporation by Reference

The entire content of the Proponent's Proposal should be submitted in a fixed form, and the content of websites or other external documents referred to in the Proponent's Proposal but not attached will not be considered to form part of its Proposal.

3.01.5 References and Past Performance

In the evaluation process, IWMC may include information provided by a Proponent's references and may also consider a Proponent's past performance or conduct on previous contracts or work with IWMC.

3.01.6 Information in RFP Only an Estimate

IWMC makes no representation, warranty or guarantee as to the accuracy of the information contained in this RFP or issued by way of addenda. Any quantities shown or data contained in this RFP or provided by way of addenda are estimates only and are for the sole purpose of indicating to Proponents the general scale and scope of the Work and in assisting IWMC with the evaluation process. It is the Proponent's responsibility to obtain all the information necessary to prepare a Proposal in response to this RFP.

3.01.7 Proponents to Bear Their Own Costs

The Proponent shall bear all costs associated with, or incurred in, the preparation and submission of its Proposal, including, if applicable, costs incurred for interviews or presentations.

3.01.8 Proposal to be retained by IWMC

IWMC will not return the Proposal, or any accompanying documentation submitted by a Proponent.

3.01.9 No Guarantee of Volume of Work or Exclusivity of Contract

IWMC makes no guarantee of the value or volume of work to be assigned to the successful Proponent. The Agreement will not be an exclusive contract for the provision of the described work. IWMC may contract with others for goods and services the same as or similar to the Work or may obtain such goods and services from IWMC's own resources.

3.01.10 Business Registration

Proponents must be registered to carry on business in Prince Edward Island in accordance with applicable federal and provincial laws prior to completing the Agreement if selected the Contractor. For information on the business registration requirements of the Consumer, Corporate and Financial Services, Department of Justice and Public Safety, please consult:

<https://www.princeedwardisland.ca/en/topic/business-name-registration>

The status of a Proponent's business registration does not preclude the submission of a proposal in response to this RFP. A proposal can be accepted for evaluation, regardless of

- a) whether the company is registered, or
- b) whether its business registration is in good standing. However, if the Proponent is selected as the successful Proponent, that Proponent must bring itself into compliance prior to the execution of the Agreement.

3.02 Execution of Agreement, Notification and Debriefing

3.02.1 Selection of Proponent and Execution of Agreement

IWMC will notify the selected Proponent(s) in writing. The selected Proponent(s) shall execute the Agreement, as attached as Appendix C to this RFP, and satisfy any other applicable conditions of this RFP within fifteen (15) days of notice of selection unless otherwise extended by IWMC.

3.02.2 Failure to Enter into Agreement

In addition to all of IWMC's other remedies, including the retention of a Proponent's Bid Security, if the selected Proponent fails to execute the Agreement or to satisfy any other applicable conditions of this RFP within fifteen (15) days of its notice of selection, IWMC may, in its sole and absolute discretion, and without incurring any liability whatsoever, withdraw the selection of that Proponent and proceed with

the selection of another Proponent or cancel the RFP Process.

3.02.3 Posting of Contract Award

Once an Agreement has been executed by IWMC with the selected Proponent, notification of the outcome of the procurement process will be posted on the Prince Edward Island Tendering Site.

3.02.4 Debriefing

Proponents may request a debriefing after the posting of the outcome of the procurement process on the Prince Edward Island Tendering Site. All such requests must be in writing to the IWMC Contact and must be made within twenty (20) days of posting of the outcome of the procurement process on the Prince Edward Island Tendering Site. The intent of the debriefing information session is to aid the Proponent in presenting a better Proposal in subsequent procurement opportunities. Any debriefing provided is not for the purpose of providing an opportunity to challenge the procurement process or its outcome.

3.03 Conflict of Interest and Prohibited Conduct

3.03.1 Conflict of Interest

IWMC may disqualify a Proponent for any conduct, situation or circumstances determined by IWMC, in its sole and absolute discretion, to constitute a Conflict of Interest. For the purposes of this Section, "Conflict of Interest" has the meaning ascribed to it in the General Proposal Submission Form and Requirements (Appendix B).

3.03.2 Disqualification for Prohibited Conduct

IWMC, without incurring any liability to the Proponent, may disqualify a Proponent, or terminate an Agreement entered into if IWMC, in its sole and absolute discretion, determines that the Proponent has engaged in any conduct prohibited by this RFP.

3.03.3 Prohibited Proponent Communications

A Proponent shall not engage in any communications that could constitute a Conflict of Interest and should take note of the Conflict of Interest declaration set out in the General Proposal Submission Form and Requirements (Appendix B).

3.03.4 Proponent not to Communicate with Media

A Proponent may not at any time directly, or indirectly, communicate with the media in relation to this RFP or any agreement entered into pursuant to this RFP without consent of IWMC, and then only in coordination with IWMC.

3.03.5 No Lobbying

A Proponent shall not, in relation to this RFP or the evaluation and selection process, engage directly or indirectly in any form of political or other lobbying whatsoever to influence the selection of the successful Proponent.

3.03.6 Illegal or Unethical Conduct

Proponents shall not engage in any illegal business practices, including activities such as bid-rigging, price-fixing, bribery, fraud, coercion, or collusion. Proponents shall not engage in any unethical conduct, including lobbying, as described above, or other inappropriate communications; offering gifts to any employees, officers, agents, elected or appointed officials or other representatives of IWMC; submitting Proposals containing misrepresentations or other misleading or inaccurate information; or any other conduct that compromises or may be seen to compromise the competitive process provided for in this RFP.

3.03.7 Rejection of Proposal

IWMC may reject a Proposal based on past performance or based on inappropriate conduct, including, but not limited to, the following:

- a) illegal or unethical conduct as described in this RFP;
- b) the refusal of the Contractor to honour its submitted pricing or other commitments;
- c) any conduct, situation or circumstance determined by IWMC, in its sole and absolute discretion, to have constituted an undisclosed Conflict of Interest; or
- d) IWMC's past experience with the Proponent for similar or related services.

3.04 **Confidential Information**

3.04.1 Confidential Information of IWMC

All information provided by, or obtained from, IWMC in any form in connection with this RFP either before or after the issuance of this RFP

- a) is the sole property of IWMC and must be treated as confidential;
- b) is not to be used for any purpose other than replying to this RFP and the performance of the Agreement; and,
- c) must not be disclosed to any third party without the prior written authorization from IWMC, and
- d) must be returned by the Proponent to IWMC immediately upon request of IWMC.

3.04.2 Confidential Information of Proponent

A Proponent should identify any information in its proposal, or any accompanying documentation supplied in confidence for which confidentiality is to be maintained by IWMC. The confidentiality of such information will be maintained by IWMC, except as otherwise required by law or by order of a court or tribunal. Proponents are advised that their proposals will, as necessary, be disclosed, on a confidential basis, to advisers retained by IWMC to advise or assist with the RFP process, including the evaluation of proposals.

Proponents are also advised that all documents forming part of the RFP process, including all submitted proposals, are subject to the *Freedom of Information and Protection of Privacy Act* R.S.P.E.I. 1988, Cap. F-15.01 (“FOIPP”). A copy of FOIPP is available online at:

<https://www.princeedwardisland.ca/en/legislation/all/all/a>

3.04.3 Personal Information International Disclosure Protection Act

The *Freedom of Information and Protection of Privacy Act* R.S.P.E.I. 1988, Cap. F-15.01 (“FOIPP”) governs the collection, use and disclosure of personal information by IWMC and its service providers. The successful Proponent shall be required to comply with all requirements of FOIPP during the term of the Agreement.

A copy of FOIPP is available online at: <https://www.princeedwardisland.ca/en/legislation/all/all/a>

3.05 Reserved Rights, Limitation of Liability and Governing Law

3.05.1 Reserved Rights of IWMC

IWMC reserves the right to:

- a) make public the names of any or all Proponents;
- b) request written clarification in relation to a Proponent’s Proposal;
- c) waive minor formalities that do not constitute Mandatory Submission requirements or Mandatory Technical requirements;
- d) verify with any Proponent or with a third party any information set out in a Proposal;
- e) check references other than those provided by any Proponent;
- f) disqualify any Proponent whose Proposal contains misrepresentations or any other inaccurate or misleading information;
- g) disqualify any Proponent or the Proposal of any Proponent who has engaged in conduct prohibited by this RFP;
- h) amend this RFP process without liability at any time prior to the execution of a written agreement between IWMC and a Proponent. These changes are issued by way of addendum in the manner set out in this RFP;
- i) cancel this RFP process without liability at any time prior to the execution of a written agreement between IWMC and a Proponent. A cancellation is communicated by way of addendum in the manner set out in this RFP. IWMC may in its sole discretion issue a new RFP for the same or similar Work; or
- j) reject any or all Proposals;

and these reserved rights are in addition to any other express rights or any other rights that may apply in the circumstances.

3.05.2 Limitation of Liability

By submitting a Proposal, each Proponent agrees that:

- a) neither IWMC nor any of its employees, officers, agents, elected or appointed officials, advisors or representatives will be liable, under any circumstances, for any claim, loss or damage arising out of this Proposal process including but not limited to costs of preparation of the Proposal, loss of profits, loss of opportunity or for any other claim;
- b) the Proponent irrevocably waives any claim for any compensation of any kind whatsoever, including claims for costs of preparation of the Proposal, loss of profit or loss of opportunity by reason of IWMC's decision to not accept the Proposal submitted by the Proponent, to enter into an agreement with any other supplier or Proponent (including a non-compliant Proponent) or to cancel this RFP process; and

3.05.3 Governing Law and Interpretation

These Terms and Conditions of the RFP Process:

- a) are intended to be interpreted broadly and independently (with no particular provision intended to limit the scope of any other provision);
- b) are non-exhaustive and shall not be construed as intending to limit the pre-existing rights of the parties to engage in pre-contractual discussions in accordance with the common law governing direct commercial negotiations; and
- c) are to be governed by and construed in accordance with the laws of the province of Prince Edward Island and the federal laws of Canada applicable therein.

[End of Part 3]

APPENDIX A – RFP PARTICULARS

1. OVERVIEW OF THE WORK

Though set forth in detail in this RFP, and in the Sample Agreement in Appendix C (the “Agreement”) the general scope of the Work the Contractor will perform is the provision of residential waste and organics collection services for a 5-year term. Such collection services are anticipated to commence on November 1, 2024 and conclude on October 31, 2029. IWMC shall have the right, at its sole option and discretion, to extend the resulting Agreement in accordance with the terms and conditions of the Agreement.

IWMC’s residential collection program consists of curbside collection of source-separated waste (e.g., non-recyclable plastics and textiles) and organics (e.g., food waste, non-recyclable paper products, leaf and yard waste) throughout the province of Prince Edward Island and the transportation of these materials to the appropriate final disposal facility. In addition, the Work includes aspects related to customer service, quality control (i.e., tagging/stickering for warnings/rejections), and data management. Schedule B of the Agreement, (the “Work Specification”) details the requirements for the provision of collection services.

The types of properties that qualify for collection services for this RFP (the “**Serviced Units**”) are as defined in the Work Specification.

IWMC’s residential collection program is summarized in the below Table A1.

Table A1 – Summary of IWMC’s Residential Collection Program

(Note: This is a summary only. Specific details of the residential Waste Watch guidelines can be found in the Work Specification).

	Waste Collection	Organics Collection
Frequency	Bi-Weekly (i.e., every other week)	Bi-Weekly (i.e., every other week)
Acceptable Containers or placement of materials for curb side collection	<ol style="list-style-type: none"> 1. 240 L (or 140 L) Black Cart provided by IWMC. 2. For excess Waste: - rigid containers; - Clear Bags. See Section 5.4(d) in Work Specification. 3. Large item(s) not requiring a container but within weight/size guidelines may be placed beside cart. 	<ol style="list-style-type: none"> 1. 240 L (or 140 L) green cart provided by IWMC 2. For excess organics: - rigid containers; - Paper Bags - Compostable Bags See Section 5.4(e) in Work Specification 3. Tree debris Bundles
Additional Collection Services (See Section 1.1)	Spring and Fall Clean-up (Occurs during regular waste collection weeks in May and November. Separate collection not required)	Spring and Fall Clean-up (two weeks for each) Christmas tree collection (once in January)
Program Details (e.g., acceptable items)	https://iwmc.pe.ca/wp-content/uploads/2021/09/FINAL-Sorting-Guide-Special-Disposals-Sept15-2021-SMALL.pdf	https://iwmc.pe.ca/wp-content/uploads/2021/09/FINAL-Sorting-Guide-Special-Disposals-Sept15-2021-SMALL.pdf

As noted in Table A1, waste and organics are collected on a bi-weekly basis (i.e., once every two weeks, alternating), with waste and organics collection occurring on alternate weeks. Within the Region, the collection of Waste or Organics will occur on the same day of the week.

1.1 Additional Services

- a) **Christmas Tree Collection:** The Contractor is required to provide a separate collection for Christmas Trees (must be collected separate from organic green cart materials) during one week in January each year. The week will be determined by IWMC and will be published in advance in IWMC's semi-annual Newsletter which includes the collection calendar and sorting guide. It is typically the first or second week in January.

All trees collected are the property of IWMC and will usually be delivered to the Central Compost Facility, although IWMC reserves the right to direct these trees to the East Prince Waste Management Facility in Wellington Centre or other approved facilities/locations.

Historically, the Eastern Kings Region has produced an average of 15 metric tonnes per year.

Typically, trees longer than eight feet shall be cut in half for collection purpose. Section 5.9 of Schedule B "Work Specification" provides further details.

- b) **Spring and Fall Cleanup Collection:** Residents are provided with Spring and Fall collections for volumes of materials not usually collected in regular weekly collections. For Organics, the Contractor must provide a separate collection. Spring and Fall Cleanup Waste materials can be collected at the same time as the waste carts. Materials must be delivered to the disposal facility specified by IWMC.

Spring and Fall Cleanup consists of two weeks for organics (e.g., leaves, tree branches), which is normally the first and third weeks of May and November. For waste items (e.g., bags of waste from cleaning out a basement, attic or garage) materials are placed curbside by residents on their regularly scheduled waste collection day during the months of May and November. The volume of waste materials for Spring and Fall Cleanup has been quite low in recent years, almost negligible when compared to normal waste collection weeks.

Residents are instructed to use rigid containers or paper bags for organics (e.g., leaves) and bundle and tie multiple items such as twigs/branches, and to use rigid containers or clear bags for waste materials. Larger waste items may also be placed curbside without being contained, such as a broken wooden chair, larger toys, expired car seat, etc.

IWMC reserves the right to amend the types of materials collected and the weekly schedule as may become necessary during the Operating or Extension term(s).

Section 5.8 of Schedule B, Work Specification provides further details.

1.2 Health and Safety

IWMC is committed to protecting the health, safety and well-being of all its employees and to providing and maintaining a safe and healthy work environment. IWMC will take commercially reasonable

measures to reduce any foreseeable hazards in IWMC workplaces that may result in personal injury or illness to employees, contractors, suppliers, volunteers or the general public.

The Proponent is required under this RFP and the Agreement to assume the primary responsibility for creating and maintaining a secure, safe and healthy workplace.

Proponents shall have a Health and Safety Plan that includes appropriate safety procedures and protocols for the collecting, handling and transporting of waste materials. Health and Safety Plans must comply with all requirements of the Agreement including the Work Specification and ensure the appropriate use of personal protective equipment. All employees must be trained in these health and safety procedures and protocols.

Proponents shall submit a copy of their Health and Safety Plan as part of their Technical Proposal. Topics to be included in the Health and Safety Plan are as outlined in the Work Specification. The successful Proponent shall provide IWMC with updates to its submitted Health and Safety Plans that may occur from time to time during the term of the Agreement. In addition, the successful Proponent shall comply with the reporting requirements of the Agreement including reporting items such as spills, motor vehicle accidents, and other incidents which might be considered to impact the health and safety of their employees or the public or the environment.

1.3 Customer Service and Quality Control

As part of the delivery of the Work, Proponents will be expected to provide customer service through direct contact with IWMC's Customer Service Center staff and with residents. Customer service requirements are outlined in the Work Specification as part of the Agreement.

IWMC and the successful Proponent will provide services in a customer-focused manner. Adherence to customer service standards will be monitored and tracked as part of periodic monitoring and annual reviews. The successful Proponent shall attend regularly scheduled review meetings with IWMC to help maintain clear and effective lines of communications as outlined in the Work Specification. In addition, the successful Proponent shall make their staff available (i.e., management and drivers) to participate in in-person meetings with IWMC.

As outlined in the Work Specification and as part of maintaining quality control for the Work, the successful Proponent shall maintain Daily Drivers Reports and utilize education tags/stickers and apply the criteria as developed by IWMC for use of education tags/stickers throughout the term of the Agreement. The successful Proponent's drivers and collectors, supervisors, and administrative personnel shall participate in meetings with IWMC on a regular basis, as reasonably scheduled by IWMC, to provide focus for training-related topics such as program consistency, policy, education, tagging/stickering, and customer service.

1.4 Diversity and Inclusion

- a) IWMC values diversity and inclusion.

"Diversity is the range of visible and invisible qualities, experiences and social and cultural identities that shape who we are, how we think and how we engage with, and are perceived by

the world. These can be along the dimensions of age, skin colour, gender, national origin, ethnicity or physical/mental ability, and also includes other dimensions such as economic status, sexual orientation, gender identity, education level, family status, thinking styles, geographic location, first language, immigration/refugee status, socioeconomic background, religious/spiritual beliefs, or political ideologies and many more. They can also include differences such as personality, style, capabilities, and thoughts/perspectives.” (Source: Province of Prince Edward Island Diversity and Inclusion Policy)
<https://www.princeedwardisland.ca/sites/default/files/publications/diversityandinclusionpolicyenglish.pdf>

- b) IWMC recognizes diversity and inclusion as core values which lay the foundation to represent the communities it serves.

“Inclusion is an attitude and approach that embraces diversity in the workplace where all employees feel valued and have a sense of belonging within an organization that applies the principles of equity and fairness in all aspects of its policies, practices, procedures and service delivery. An inclusive environment enables individuals and groups to feel safe, respected, engaged, motivated, and valued, for who they are and for their contributions toward organizational and societal goals.” (Source: Province of Prince Edward Island Diversity and Inclusion Policy)
<https://www.princeedwardisland.ca/sites/default/files/publications/diversityandinclusionpolicyenglish.pdf>

As frontline service providers for IWMC, successful Proponents will be expected to show a commitment to the principles of diversity and inclusion, including having a D&I policy.

1.5 Collection Vehicles

At the commencement of the Operational Term at least 80% of the collection vehicles used by the Contractor to perform the Work shall be model year 2019 or newer. The remainder shall be 2015 or newer. IWMC acknowledges that due to delivery times on new solid waste collection vehicles, a reasonable transition period may be required at service commencement (i.e., November 1, 2024) and such transition period, if needed, will be negotiated between IWMC and the successful Proponent.

Furthermore, at any time during the Operational Term or Extension Term(s), ages of the collection vehicles used by the Contractor to perform the Work shall adhere to this ratio of 80%/20% with the respective model years being increased by one year on each one year anniversary date of the commencement of the Operational Term.

1.6 Collection Regions

The residential collection program for this RFP is the Eastern Kings Region. The Collection Map and the Collection Schedule are provided with this RFP (Attachment #1).

Proponents are responsible for:

- a) Ensuring they are completely familiar with the Region.
- b) Examining the Region and applicable service boundary(s) to be fully knowledgeable of the areas

to be collected.

1.7 Eastern Kings Region

The Eastern Kings Region includes residences in zones A, A1, A2, B, D and D1. Refer to attachment #1 – Eastern Kings Region for the details and scheduled collection days.

As at October 31, 2022, the Eastern Kings Region encompassed 4,158 year round households, of which there is 1 property that has 12 or more units totalling 14 apartment units, as per Attachment 3 (Apartment List – Eastern Kings Region).

Also included in the year round household counts are 4 church properties which are serviced under the residential program.

As at October 31, 2022 there were 1,212 seasonal residences (cottages) and 170 extended seasonal residences in the Region. Seasonal Residences collection begins the week of June 1st each year and continues until the week of September 30th. Collection for Extended Seasonal residences are usually scheduled to begin on the Monday of the week that includes May 15th and are concluded in the week that includes October 31st. IWMC will advise the Contractor each year of the exact collection start and end times.

Note: A seasonal property having three or more seasonal residences may be exempted from residential collection services, as the owner may opt for this property to be considered commercial, in which case they will be removed from the household count and reflected on the next household count adjustments.

1.8 Multi-Unit (Apartment) Collections

Attachment 3 (Apartment List for Eastern Kings Region) provides a breakdown of the multi-unit properties (12 or more) currently in this service area which are serviced by regular IWMC 240 L carts. Collection details are provided in the Work Specification Section 5.10.

1.9 Backyard Collections

IWMC may approve special residential collection services from time-to-time which will be forwarded to the Contractor. This may include, but is not limited to, backyard collections for residents whose medical or other condition limits their ability to place material curbside.

There are currently 12 backyard collections in the Eastern Kings Region. Collection details are provided in the Work Specification Section 5.11.

Final Disposal Facilities

1. Final Disposal Facilities for Waste and Organics are as follows.

Waste – Primary Disposal Facility
PEI Energy Systems

40 Riverside Drive, Charlottetown

Hours of Operation: Monday to Friday – 7 AM to 4:30 PM; Saturdays – 7 to 11 AM

Organics – Primary Disposal Facility

Central Compost Facility

Route 226, Brookfield, PEI

Hours of Operations: Monday to Friday – 8 AM to 5 PM; Saturdays – Closed

Waste – Secondary Disposal Facility

East Prince Waste Management Facility

Route 2, Wellington Centre, PEI

Hours of Operation: Winter (approximately mid-September to April) – Monday to Friday – 8 AM to 4:30 PM; Saturdays – 8 AM to 12:30 PM

Summer (approximately May to mid-September) – Monday to Friday – 7 AM to 4:30 PM; Saturdays – 7 AM to 12:30 PM

Organics – Secondary Disposal Facility

East Prince Waste Management Facility – see above

1.10 Tonnage Data

Table A2 and A3 below show the collection tonnages for each material type for Fiscal Year 2021/2022 (March to April).

**Table A2: Waste Tonnage Including Spring/Fall Clean-up
April 1, 2021 to March 31, 2022**

Month	Eastern Kings Region
April	82
May	106
June	113
July	104
August	99
September	106
October	193
November	136
December	114
January	111
February	122
March	101
Year to Date	1,387
Households by Region	4,158
Average Weight per Household (kg)	333

**Table A3: Organics Tonnage Including Spring/Fall Collections and Christmas Tree Collection
April 1, 2021 to March 31, 2022**

Month	Eastern Kings Region
April	105
May	62
June	61
July	59
August	91
September	55
October	63
November	38
December	37
January	33
February	47
March	50
Year to Date	701
Households by Region	4,158
Average Weight per Household (kg)	169

2. PROPOSAL REQUIREMENTS FOR RATED CRITERIA

2.1 Technical Proposal

Proponents must submit Technical Proposals in accordance with this Section 2.1. Proposal headings and subheadings should match and be set out in the order of the bolded and underlined text below, respectively. Proponents must submit the requested information. Additional information may be submitted as appendices. Proponents should attempt to confine Technical Proposals to 25 consecutive pages, excluding cover pages, tables or figures that are on a full page, and appendices.

When reviewing Technical Proposal requirements, Proponents should also review the Agreement, included as Appendix C to this RFP, including the Agreement’s Schedule B - Work Specification.

2.1.1 Proponent Corporate Profile and Reference Experience (Maximum of 20 points available)

- a) **Corporate Profile:** The proposal should describe the Proponent’s corporate background, including an outline of the Proponent’s experience and qualifications related to the Work, as well as the details of the Proponent’s approach to performance of the collection and transportation services, environmental responsibility including mitigating greenhouse gas emissions, health and safety, and diversity and inclusion.

This section should also provide details of the business structure of the Proponent including, but not limited to, such items as ownership structure, an overview of the Proponent’s business registration, its organizational chart and related companies.

- b) **Reference Experience:** Proponent should list their relevant experience and references for work related to residential collection, including waste and organics collection, and other comparable sectors over the previous five (5) years. The proposal should include a table with a summary of relevant experience of similar size and scope and include a description of the services provided, location, time period, client information including reference contact person(s) telephone number and e-mail address.

2.1.2 Equipment, Maintenance, and Sustainability of Collection Fleet (Maximum of 24 points available)

- a) **Suitability of Equipment/Collection Fleet:** Proposals must include a list of the proposed equipment and collection fleet to be used in two separate summary tables for waste and organics that includes the following:

- Region
- Vehicle Type
- Make/Model
- Capacity
- Date of Manufacture
- Fuel Type
- Lifter type/supplier (as applicable)

Collection vehicles used to perform the Work shall be well maintained to provide reliable and safe collection services and at the commencement of the Operational Term at least 80% of the collection vehicles used by the Contractor to perform the Work shall be model year 2019 or newer. The remainder shall be 2015 or newer. Furthermore, at any time during the Operational Term or Extension Term(s), ages of the collection vehicles used by the Contractor to perform the Work shall adhere to this ratio of 80% / 20% with the respective model years being increased by one year on each one year anniversary date of the commencement of the Operational Term.

With respect to age of collection vehicles, Proponents may include any non-conforming collection vehicles that may be required to be used at start-up during a transitional period until new collection vehicles are received, and indicate clearly how long the non-conforming collection vehicles will be used.

Proponents must indicate whether a proposed collection vehicle will be used for regular services or considered a spare vehicle.

Proponents may submit additional information including specifications, pictures, etc. for their collection equipment as part of their proposal in an appendix.

Proponents should include in this section of their submission, their proposed AVL¹/GPS solution for collection equipment (see the Work Specification for AVL/GPS requirements). Additional

1 Automatic Vehicle Locator

information on the AVL/GPS may be submitted in an appendix.

- b) **Maintenance Plan:** Proposals should include details (e.g., type and location) of the proposed garage and maintenance facilities for the equipment to be used by the Proponent to perform the Work. As part of this, Proponents should provide details on cleaning of collection fleet equipment and contingency plans for how collection fleet breakdowns will be managed. In addition, Proposals should include details on the Proponent's ongoing maintenance plan to ensure the reliability of its collection vehicle fleet. Additional maintenance plan information, such as details of items included for each type and preventative maintenance forms, should be included in an appendix.
- c) **Sustainability Considerations:** Proposals should include details on how the Proponent will address environmental sustainability during the term of the Agreement, in particular details should be provided with respect to how a Proponent's plan will support IWMC in meeting the Province of PEI 2040 Net Zero Framework. A copy of the Net Zero Framework is found at: https://www.princeedwardisland.ca/sites/default/files/publications/2040_net_zero_framework_k_for_feb_23_2022.pdf. Such details may include plans to utilize existing or new collection vehicles that use cleaner energy sources and/or are more efficient in terms of reducing greenhouse gas emissions. In addition, Proponents should provide other details that address other sustainability considerations such as waste management and green procurement for equipment and supplies.

2.1.3 Proponent Team and Customer Service (Maximum of 18 points available)

- a) **Proponent Team:** Proposals should include an organizational chart showing key personnel, including the Proponent's proposed Solid Waste Collection Representative, managers, supervisors and administrative Personnel (as detailed in the Agreement). Curriculum vitae (CVs) for key individuals should be provided as an appendix to the proposal with each CV being no longer than two pages and should clearly identify relevant experience and qualifications, including years of experience.
- b) **Customer Service:** Proposals should include details on how the Proponent will approach customer service, including:
 - i. Meeting IWMC's customer service standards as outlined in the Agreement and Work Specification.
 - ii. Outlining how frontline staff, supervisors, and administrative personnel will interact with IWMC staff and customers.
 - iii. Training programs including meeting the requirements of the Agreement including the Work Specification.

2.1.4 Collection Plan: Health and Safety, and Data Management (Maximum of 18 points available)

- a) **Eastern Kings Region Collection Schedule:** IWMC has established Collection Maps and Schedules, see Attachment #1. The Proponent must demonstrate they understand the maps and collection schedules and will adhere to the current Collection Schedules as part of their plan. During this Agreement the Contractor may request changes to the collection maps and schedules. The Contractor must demonstrate how the proposed changes would improve the collection process and enhance service to customers. Any changes approved by IWMC would require sufficient notification to, and education for, affected residents, and take time to complete and implement.

- b) **Health and Safety:** Proponents should provide an overview of their health and safety programs and Health and Safety Plan:
 - i. The Health and Safety Plan should be submitted as an appendix to the proposal and at a minimum should meet the requirements of the Agreement and Work Specification.
 - ii. A Letter of Good Standing from the PEI Workers Compensation Board, or equivalent body in other jurisdictions, should be submitted as an appendix to the proposal.
 - iii. A letter of Good Standing from PEI Occupational Health and Safety, or equivalent body in other jurisdictions, should be submitted as an appendix to the proposal.

- c) **Data Management:** Proposals should outline briefly how the Proponent will manage and share data with IWMC in accordance with the Agreement, including:
 - i. Drivers Daily Reports
 - ii. Monthly fleet information in support of IWMC’s efforts to develop detailed greenhouse gas emission inventories (e.g., fuel type, fuel consumption, distance travelled) per collection vehicle per stream (i.e., waste and organics)
 - iii. Incident, monthly and annual reporting as outlined in the Work Specification.

2.2 Cost Proposal

A Cost Proposal Submission Form, in Microsoft Excel Format, has been included as Schedule A to the Agreement within the RFP documents for the Region.

The Cost Proposal Submission Form is provided for Proponents to use in the preparation of their Cost Proposal. When completed, it will be a “Working Copy”.

1. The Cost Proposal Submission Form should be completed fully by inserting the unit price proposed in the appropriate cell for the collection type and the year. Columns H and I will automatically calculate and update throughout the process.

2. Submission Instructions for the Cost Proposal:
 - a) Upon completion, the Cost Proposal Submission Form should be printed off by the Proponent and signed (authorized) at the bottom using pen and ink. This printed signed form will be the “Authorized Copy” of the Cost Proposal Submission.

- b) Both the Working Copy and the Authorized Copy of the Cost Proposal Submission Form must be included with the Proponent's Submission as follows:
 - i. The Working Copy must be submitted as a separate Microsoft Excel file, named "Working Copy Cost Proposal Submission". The Working Copy Form does not require signature or authorization.
 - ii. The Authorized Copy must be submitted as a separate PDF file named "Authorized Copy Cost Proposal Submission".
- c) For Clarity, the Authorized Copy of the Proponent's Cost Proposal Submission shall contain the Proponent's submitted cost information that is evaluated by IWMC. If there is a discrepancy between the Authorized Copy and the Working Copy, IWMC will only consider and evaluate the Authorized Copy as the Proponent's Submitted Cost Proposal.
- d) Currency and HST
 - i. Proponents shall provide their pricing information in Canadian Funds, inclusive of all applicable costs and duties and other charges but excluding HST. While HST will be charged to IWMC when services are invoiced, it is not to be included in the Cost Proposal Submission.

APPENDIX B

GENERAL PROPOSAL SUBMISSION FORM AND REQUIREMENTS

(To be completed, signed and submitted in its entirety)

1. Proponent Information

Proponents must complete the following form, naming one person to be the proponent's contact for the RFP process and for any clarifications or communication that might be necessary.	
Full Legal Name of Proponent:	
Any Other Relevant Name under which Proponent Carries on Business:	
Street Address:	
City, Province/Territory/State:	
Postal Code:	
Phone Number:	
Company Website (if any):	
Proponent Contact Name and Title:	
Proponent Contact Phone:	
Proponent Cell Phone:	
Proponent Contact Email:	
HST / GST Registration Number:	

2. Offer

The Proponent has carefully examined the RFP documents and has a clear and comprehensive knowledge of the Work IWMC requires the Proponent to perform. By submitting a proposal, the Proponent agrees and consents to the terms, conditions and provisions of the RFP, including those set forth in the Agreement (Appendix C), and the Work Specification and offers to provide the Work in accordance therewith at the prices set out in its completed Cost Proposal.

3. Rates

The Proponent has submitted its proposed rates in accordance with the instructions in the RFP and in the Cost Proposal Submission Form (Schedule A) The Proponent confirms that it has factored all of the provisions of the Agreement (Appendix C) including insurance and indemnity requirements, into its pricing assumptions and calculations.

4. Addenda

By submitting a Proposal, the Proponent is deemed to have read and considered all addenda issued by IWMC. The onus is on the Proponent to make any necessary amendments to its proposal based on the addenda issued.

5. No Prohibited Conduct

The Proponent declares that it has not engaged in any conduct prohibited by this RFP.

6. Conflict of Interest

For the purposes of this RFP, the term “Conflict of Interest” includes, but is not limited to, any situation or circumstance where:

- a) in relation to the RFP process, the Proponent has an unfair advantage or engages in conduct, directly or indirectly, that may give it an unfair advantage, including but not limited to:
 - i. having, or having access to, confidential information of IWMC in the preparation of its proposal that is not available to other proponents,
 - ii. communicating with any person with a view to influencing preferred treatment in the RFP process (including but not limited to the lobbying of decision makers involved in the RFP process), or
 - iii. engaging in conduct that compromises, or could be seen to compromise, the integrity of the open and competitive RFP process or render that process non-competitive or unfair; or
- b) in relation to the performance of its contractual obligations contemplated in the Agreement that is the subject of this procurement, the Proponent’s other commitments, relationships or financial interests
 - i. could, or could be seen to, exercise an improper influence over the objective, unbiased and impartial exercise of its independent judgement, or
 - ii. could, or could be seen to, compromise, impair or be incompatible with the effective performance of its contractual obligations.

Proponents should disclose the names and all pertinent details of all individuals (employees, advisers, or individuals acting in any other capacity) who participated in the preparation of the proposal **AND** who were employees of IWMC within twelve (12) months prior to the Submission Deadline.

If the box below is left blank, the Proponent will be deemed to declare that:

- a) there was no Conflict of Interest in preparing its proposal; and
- b) there is no foreseeable Conflict of Interest in performing the contractual obligations contemplated in the RFP. Otherwise, if the statement below applies, Proponents must check the box.

- The Proponent declares that there is an actual or potential Conflict of Interest relating to the preparation of its proposal, and/or the Proponent foresees an actual or potential Conflict of Interest in performing the contractual obligations contemplated in the RFP.

If the Proponent declares an actual or potential Conflict of Interest by checking the box above, the Proponent must set out below details of the actual or potential Conflict of Interest:

7. Proposal Irrevocable

The proponent agrees that its proposal shall be irrevocable for a period of **one hundred and forty (140)** days (20 weeks) following the Submission Deadline.

8. Disclosure of Information

The Proponent hereby agrees that any information provided in this proposal, even if it is identified as being supplied in confidence, may be disclosed where required by law or by order of a court or tribunal. The Proponent hereby consents to the disclosure, on a confidential basis, of this proposal by IWMC to the advisers retained by IWMC to advise or assist with the RFP process, including with respect to the evaluation of this proposal.

9. Proposed Regions

The Proponent hereby submits a proposal in accordance with the RFP, including the Agreement and Work Specification, for the collection and transportation of source-separated solid waste in the Eastern Kings Region.

10. Performance Security and Insurance

The following companies are willing to provide the required Performance Security and Insurance, respectively.

The name of the Proponent’s insurance company which will provide the required insurance as set forth in Section 8 of the Agreement is: _____

The name of the Proponent’s chartered bank, surety company or financial institution who will provide the Performance Security as set forth in Section 4.16 of the Agreement is: _____

11. Execution of Agreement

The Proponent acknowledges and agrees that it has carefully and fully investigated all aspects of this RFP, including all schedules, appendices, the Agreement, Work Specification, and Addenda which may have been issued by IWMC and that it has been sufficiently informed itself as to the Work to be performed in accordance with this RFP.

The Proponent agrees that in the event its proposal is selected by IWMC, it will finalize and execute the Agreement in the form set out in Appendix C to this RFP in accordance with the terms of this RFP.

By signing and authorizing the submission of this Proposal, the Proponent Representative hereby declares that they have the authorization to submit this Proposal on behalf of the Proponent and to bind the Proponent to it.

Signature of Witness

Signature of Proponent Representative

Name of Witness

Name of Proponent Representative

Title of Proponent Representative

Date

I have the authority to bind the Proponent

APPENDIX C – FORM OF AGREEMENT

SAMPLE AGREEMENT

**Collection and Transportation of Residential Waste and Organics (Compostables)
For the Eastern Kings Region**

THIS AGREEMENT made this _____ day of _____, 20__.

BETWEEN:

ISLAND WASTE MANAGEMENT CORPORATION, a Crown Corporation,

(hereinafter referred to as "IWMC")

OF THE FIRST PART;

AND:

[INSERT LEGAL NAME OF CONTRACTOR], **OF** [enter address] in _____ County,
Province of Prince Edward Island.

(hereinafter referred to as the "**Contractor**")

OF THE SECOND PART.

WHEREAS IWMC issued a Request for Proposals entitled *Collection and Transportation of Residential Waste and Organics (Compostables) for the Eastern Kings Region* dated [Insert Date], (the "**RFP**"), inviting submission of proposals to provide the Work, as hereinafter defined;

AND WHEREAS the Contractor submitted a proposal to IWMC dated [Insert Date], (the "**Contractor's Proposal**") in response to the RFP;

AND WHEREAS the Contractor has been evaluated as the Preferred Proponent and selected by IWMC for the residential collection of waste and organics within the Eastern Kings Region and its transportation to the designated receiving facilities;

NOW THEREFORE in consideration of the mutual promises set out herein, the Contractor and IWMC agree as follows:

1. Definitions

1.1 Definitions - Words and Phrases

In this Agreement, including the recitals, unless the context requires otherwise, the following words and phrases shall have the meanings hereinafter set out, namely:

- (a) "**Agreement**" means this agreement between the Parties including the recitals, the schedules and appendices hereto, and any amendments thereto made by the Parties from time to time, all of which are deemed to be incorporated by reference to this Agreement.
- (b) "**Applicable Laws**" means any statute, law, by-law, rule, regulation, guideline, judgment or order of any federal, provincial, municipal or other governmental body having jurisdiction, applicable from time to time to the collection and transportation of Source-Separated Solid Waste and Organics or any other transaction or matter contemplated hereby.
- (c) "**Area**" or "**Areas**" means the Eastern Kings Region.
- (d) "**Automobile Insurance**" has the meaning set forth in Section 8.2(a)(ii).
- (e) "**AVLT**" has the meaning set forth in Section 3.7(d) of Schedule B – Work Specification.
- (f) "**Benchmark Diesel Fuel Price**" means \$____per litre as set forth in Section 7.3(a) of this agreement.
- (g) "**Bi-Weekly Organics Collection**" has the meaning set forth in Section 6.1(a)(ii) of Schedule B – Work Specification.
- (h) "**Bi-Weekly Waste Collection**" has the meaning set forth in Section 6.1(a)(i) of Schedule B – Work Specification.
- (i) "**Cart**" means the wheeled carts provided to residences by IWMC further detailed in Schedule B – Work Specification.
- (j) "**Cart Lifter**" or "**Lifter**" means a semi-automated or automated lifting mechanism including hydraulic pumps, valves, hosing and installation designed for universal use with both styles of Carts.
- (k) "**Central Compost Facility**" means the composting facility for processing Organics located in Brookfield, PEI or any future organics processing facility located at this site.
- (l) "**Change Certificate**" has the meaning set forth in Section 15.
- (m) "**Change Order**" means a change, including an addition, deletion, alteration, substitution or

otherwise, to the Work or IWMC's or the Contractor's obligations which shall follow the process set forth in Section 15 of this Agreement.

- (n) "**Christmas Tree Collection**" has the meaning set forth in Section 5.9 of Schedule B – Work Specification.
- (o) "**Collection and Transportation**" means the Contractor's action of picking up and loading Source-Separated Solid Waste and Organic materials from Serviced Units, into the Contractor's collection vehicles, transporting it to the appropriate Final Disposal Facility, and weighing and unloading it in accordance with this Agreement.
- (p) "**Commercial General Liability Insurance (CGL)**" has the meaning set forth in Section 8.2 (a)(i).
- (q) "**Confidential Information**" has the meaning set forth in Section 16.
- (r) "**Contractor**" means the legal entity set forth in the first page of this Agreement, whose proposal was accepted by IWMC to perform the Work.
- (s) "**Contractor Diesel Fuel Payment**" has the meaning set forth in Section 7.3(e).
- (t) "**Contractor's Proposal**" means the submission made by the Contractor in response to the RFP.
- (u) "**Customer Service**" has the meaning set forth in Section 11.1 of Schedule B – Work Specification.
- (v) "**Deduction**" has the meaning set forth in Section 14.1.
- (w) "**Diesel Fuel High Target**" has the meaning set forth in Section 7.3(b).
- (x) "**Diesel Fuel Low Target**" has the meaning set forth in Section 7.3(b).
- (y) "**Diesel Fuel Price Change**" has the meaning set forth in Section 7.3.
- (z) "**Drivers Daily Report**" has the meaning set forth in Section 12.1 of Schedule B – Work Specification.
- (aa) EPWWMF means "**East Prince Waste Management Facility**". EPWWMF is a waste receiving facility located at 29786 Highway 2, Wellington Centre, PEI, which is the landfill.
- (bb) "**Effective Date**" has the meaning set forth in Section 2.1.
- (cc) "**Environmental Damage or Degradation**" means an impairment and / or damage to the environment and its constituent elements (including in water, soil or air), human health or safety or property, in violation of Applicable Laws (including, Applicable Laws enacted after the time at which the Hazardous Substance causing the contamination is first present), caused by the presence of a

contaminated material and / or a Hazardous Substance, and may include having an adverse effects on or death or injury to plants, animals or human beings resulting in whole or in part from such contamination.

- (dd) “**Environmental Insurance**” has the meaning set forth in Section 8.2(a)(iii).
- (ee) “**Expiry Date**” has the meaning set forth in Section 2.1.
- (ff) “**Extension Term(s)**” has the meaning set forth in Section 2.2.
- (gg) “**Final Disposal Facility**” has the meaning set forth in Section 9.1 of Schedule B – Work Specification.
- (hh) “**Force Majeure Event**” has the meaning set out in Section 9.1 of this Agreement.
- (ii) “**Hazardous Substance**” means a hazardous waste, hazardous product, contaminant, toxic substance, deleterious substance, dangerous good, pollutant, waste, reportable substance, and any other substance, in respect of which the storage, manufacture, handling, disposal, treatment, generation, use, transport, remediation or release into or presence in the environment is prohibited, controlled or regulated under Applicable Laws;
- (jj) “**ICI**” means waste, organics, recyclable or special waste materials generated from an industrial, commercial, or institutional property.
- (kk) “**Indemnified Parties**” has the meaning set forth in Section 12(b).
- (ll) “**IWMC’s Customer Service Center**” means the business unit of IWMC which receives inquiries or complaints from Residents and provides corresponding responses to such Residents.
- (mm) “**IWMC Diesel Fuel Payment**” has the meaning set forth in Section 7.3(e).
- (nn) “**Key Individuals**” has the meaning set forth in Section 4.11(b).
- (oo) “**Losses and Expenses**” has the meaning set forth in Section 12(b).
- (pp) “**Materials**” has the meaning set forth in Section 6.1(a).
- (qq) “**Monthly Diesel Fuel Price**” has the meaning set forth in Section 7.3(d).
- (rr) “**Monthly Payment Amount**” has the meaning set forth is Schedule C 1(a).
- (ss) “**Notice of Dispute**” has the meaning set forth in Section 18.2.
- (tt) “**Operations Effective Date**” has the meaning set forth in Section 2.1.

- (uu) “**Operational Term**” has the meaning set forth in Section 2.1.
- (vv) “**Organics**” or “**Organic Materials**” means material of plant or animal origin placed for Collection and Transportation from Serviced Units as further described in Section 5.6(b) Schedule B – Work Specification.
- (ww) “**Parties**” means IWMC and the Contractor together; and “**Party**” means either of them, as required by the context.
- (xx) “**Permits**” has the meaning set forth in Section 4.5.
- (yy) “**Personal Protective Equipment**” or “**PPE**” means equipment or clothing worn to minimize exposure to safety hazards in the workplace as further described in Section 4 of Schedule B – Work Specification.
- (zz) “**Plans**” has the meaning set forth in Section 12.4 of Schedule B – Work Specification;
- (aaa) “**Property Damage Insurance**” has the meaning set forth in Section 8.2(a)(i).
- (bbb) “**Required Insurance**” has the meaning set forth in Section 8.1(a).
- (ccc) “**Resident**” has the meaning set forth in Section 5.4(a) of Schedule B – Work Specification.
- (ddd) “**Schedule I Bank**” or “**Schedule II Bank**” means a bank listed in Schedule I or Schedule II, respectively, of the *Bank Act* (Canada).
- (eee) “**Secondary Receiving Facility**” has the meaning set forth in Section 9.1(c)(iii) and (iv) of Schedule B – Work Specification.
- (fff) “**Service Failure**” means a failure by the Contractor, during the Operational Term or an Extension Term(s), to perform the Work, or a component of the Work, and such failure is expressly set forth in Section 14.1.
- (ggg) “**Serviced Units**” means those types of residential dwellings, properties and other places designated by IWMC as entitled to receive the collection services of the Contractor in accordance with Schedule B – Work Specification.
- (hhh) “**Solid Waste Collection Representative**” has the meaning set forth in Section 4.11(a).
- (iii) “**Source-Separated Solid Waste**” means discarded Waste, Organics and Recyclables materials, as such terms are defined in this Agreement and further detailed in Schedule B – Work Specification, separated into the appropriate waste management streams by the generators of such material.

(jjj) **“Spring and Fall Cleanup”** has the meaning set forth in Section 5.8 of Schedule B – Work Specification.

(kkk) **“Term”** has the meaning set forth in Section 2.1.

(lll) **“Waste”** means garbage, trash, or rejected or discarded materials placed for Collection and Transportation from Serviced Units by the Contractor as further described in Section 5.6(a) of Schedule B – Work Specification.

(mmm) **“Waste Container”** has the meaning set forth in Section 5.4(a) of Schedule B – Work Specification.

(nnn) **“Weekly Schedule”** has the meaning set forth in Section 4.15.

(ooo) **“Work”** means the services, activities, operations, works, matters, obligations or other things required to be done, performed or applied by the Contractor in accordance with this Agreement, in order to collect Source Separated Solid Waste and Organic materials from Serviced Units within the specified areas and then transport such materials to the designated Final Disposal Facility and Work shall include, extras or additional services, equipment or materials as expressly permitted by IWMC under the terms of this Agreement.

(ppp) **“Work Schedule”** has the meaning set forth in section 4.15(a)(i).

1.2 Entire Agreement

This Agreement, including the recitals, any schedules attached hereto, constitutes the entire agreement between the Parties with respect to the subject matter of the Agreement and supersedes all prior negotiations, communications and other agreements, whether written or oral. No other representations, understandings, agreements, negotiations or trade customs shall be binding upon the Parties unless expressly made part of this Agreement by a further agreement in writing, signed by the Parties.

1.3 Inconsistency and Precedence

In the event of any inconsistency or conflict between this Agreement, its schedules, and any excerpt from the Contractor’s Proposal, the provisions which shall take precedence and govern are in the following order, namely:

- (a) this Agreement (excluding the schedules);
- (b) the provisions contained in the schedules to this Agreement;

- (c) any approved Plans; and,
- (d) any excerpt from the Contractor's Proposal.

2. Term and Extension Term(s)

2.1 Term

- (a) The term of this Agreement shall commence on the date set forth on the front page of this Agreement (the "**Effective Date**") and terminate on October 31, 2029 (the "**Expiry Date**"), unless earlier terminated in accordance with its terms and conditions (the "**Term**").
- (b) Notwithstanding the Effective Date, the date the Contractor shall commence performing the Work in accordance with this Agreement, shall be November 1, 2024 (the "**Operations Effective Date**"). The period between the Operations Effective Date and the Expiry Date, or the date of a termination of this Agreement, as the case may be, shall be the Operational Term (the "**Operational Term**").

2.2 Extension of Term(s)

- (a) IWMC shall have the right, at its sole option and discretion, to extend the Agreement for
 - (i) One (1) additional, three (3) year term (**First Extension Term**), and also for;
 - (ii) One (1) additional, two (2) year term (**Second Extension Term**).
- (b) Other than adjustments to the Prices to address inflation as set out in Schedule C (3), any Extension Term(s) shall be on the same terms and conditions as set forth in this Agreement unless otherwise mutually agreed by the parties in writing;
- (c) The Contractor acknowledges and agrees that IWMC has no obligation to declare an Extension Term(s). Should IWMC decide to declare an Extension Term(s), IWMC shall inform the Contractor in writing no later than six (6) months prior to the Expiry Date of the Agreement.

3. Representations and Warranties of the Contractor

3.1 Representations and Warranties

The Contractor represents and warrants to IWMC, with the intention and knowledge that IWMC is relying on each such representation and warranty in entering into this Agreement, that:

- (a) all statements contained in the Contractor's Proposal, and any certificate or other document

- delivered to IWMC under this Agreement or in connection with the Work are true and correct;
- (b) the Contractor has no knowledge of any fact that may materially adversely affect the Contractor's business or operations or its financial condition, or its ability to fulfil its obligations to IWMC under this Agreement;
 - (c) the Contractor has the personnel, experience, qualifications and other resources to provide the Work in accordance with the requirements of this Agreement;
 - (d) the Contractor has the corporate power and legal capacity to enter into, fully perform, and meet its obligations under this Agreement on the terms and conditions set out herein;
 - (e) this Agreement has been duly authorized, executed and delivered by the Contractor and constitutes a valid and binding obligation of the Contractor; and,
 - (f) the Contractor can perform the Work, and IWMC shall be entitled to utilize the Work, in accordance with the requirements of this Agreement without infringing any trade secret, patent, copyright, industrial design or other intellectual property right enforceable in Canada, and the Contractor has obtained, and will maintain, at its own expense, all requisite and appropriate authorizations and permissions, including those concerning any licenses, assignments, copyrights, patents and other intellectual property rights that are required by the Contractor to meet its obligations to IWMC hereunder.

4. Contractor's Obligations

4.1 Performance of Obligations

- (a) The Contractor shall provide the Work and discharge its duties to IWMC hereunder in a competent, professional and timely manner to the standard of care ordinarily exercised by other members of its profession under similar circumstances, and shall assign only duly qualified, competent and skilled personnel to carry out its obligations to IWMC under this Agreement.
- (b) The Contractor shall provide and furnish all labour, plant, equipment, materials, tools, personnel and other articles of whatsoever nature required by it to fully carry out the Work.
- (c) The Work shall be delivered on time and in accordance with the prices and schedule agreed to by IWMC and conform in all respects with IWMC's requirements as set forth in this Agreement and Schedule B – Work Specification. The Work shall not be deemed to be completed to the satisfaction of IWMC or accepted by IWMC until all requirements have been met by the Contractor in accordance with the terms and conditions of this Agreement.

4.2 Changes to the Work

- (a) Should the Parties wish to:
 - (i) add services or work to the Work, and such new services or work is not set forth in this Agreement including Schedule B – Work Specification; or,
 - (ii) delete components of the Work, and such components to be deleted are not set forth in this Agreement including Schedule B – Work Specification, then the Parties shall use the Change Order process to address such addition to, or deletion from, the Work.

4.3 Compliance with Laws

- (a) The Contractor shall comply with all Applicable Laws governing the conduct of its business and the provision of the Work to IWMC.
- (b) Neither the acceptance of the Contractor's Proposal, nor the execution of this Agreement by IWMC, shall be or deemed to be approval or authorization by IWMC to anything related to the business or operations of the Contractor or the provision of the Work that requires any permit or licence or approval pursuant to federal, provincial, or municipal legislation, regulations or by-laws.
- (c) The Contractor shall promptly provide to IWMC, upon written request, reasonable evidence of the Contractor's compliance with all Laws in the performance of its obligations and the Work.
- (d) In addition to any Applicable Laws with respect to the personal information of members of the public, the Contractor shall comply with all requirements of the *Freedom of Information and Protection of Privacy Act* (PEI).

4.4 Conflict of Interest

The Contractor shall not permit an actual or potential conflict of interest to arise between its obligations to IWMC under this Agreement and its obligations to any third Party. The Contractor shall immediately notify IWMC in writing of any such potential or actual conflict of interest should such arise at any time during the Term or any Extension Term(s).

4.5 Permits and Approvals

- (a) The Contractor agrees to obtain and maintain in good standing, at its sole cost and expense, all licences, permits, approvals, registrations or authorizations (collectively the "Permits") it is required to obtain in order to provide the Work. Without limiting the foregoing, professional personnel performing any part of the Work on behalf of the Contractor shall be required to comply with all applicable professional registration or licensing requirements in effect at the time such Work is being performed.

- (b) The Contractor shall promptly provide to IWMC, upon reasonable request, copies of all Permits.
- (c) If, during the performance of the Work, the Contractor becomes aware of any aspect of the Work which is not meeting any Law or Permit, or that the requirements of this Agreement are at variance with any Law or Permit, the Contractor shall promptly notify IWMC of such variance and IWMC and the Contractor shall, through the Change Order process, determine if any changes are needed to the Work.

4.6 Investigations

- (a) The Contractor acknowledges and agrees that it has visited, investigated, or is otherwise familiar with all sites, locations or other aspects of the Work, including the area(s) in which the Contractor will be performing the Work, with all Receiving Facilities and equipment utilized by IWMC in connection with the handling and management of Source-Separated Solid Waste and Organics and with all matters relating generally to the Collection and Transportation of Source-Separated Solid Waste and Organics for IWMC which may affect the performance of the Contractor's obligations under this Agreement. No plea of ignorance or other excuse of local conditions as a result of failure to make all necessary examinations by the Contractor will be accepted by IWMC as a basis for any claims for adjustment to pricing, extra compensation, any extension of time or any other failure to fully comply with the terms and conditions of this Agreement.

4.7 Time

The Contractor acknowledges that time is of the essence in respect of the performance of the Work and that any delay or failure to provide the Work in accordance with any schedule set forth in this Agreement will result in a loss, expense, and inconvenience to IWMC. Failure to meet the schedule requirements of the Work may entitle IWMC to a Deduction (Section 14) in accordance with this Agreement.

4.8 Nuisance

During the Operational Term, the Contractor and its employees, agents and representatives shall not commit or cause any nuisance at law or permit the emission of any substances, odours, liquids or excessive noises to occur as the result of the Contractor's performance of the Work.

4.9 Environment and Hazardous Substances

- (a) The Contractor shall be responsible for, and shall indemnify, defend, protect and hold IWMC, and its representatives, officers, employees, agents and contractors harmless from and against all losses which result from any Environmental Damage or Degradation that occurs during the Term that is caused by the Contractor or any of the Contractor's subcontractors during the Term.

- (b) The Contractor's obligations and responsibilities for the Environmental Damage or Degradation for which it is responsible under Section 4.9(a) shall be those obligations required by Applicable Laws, and such obligations may include, but not be limited to, investigating, monitoring, removal, remediation, restoration and/or abatement of the Environmental Damage or Destruction.
- (c) If the Contractor knows, or has reasonable cause to believe, that it has caused Environmental Damage or Degradation during the performance of the Work, the Contractor shall immediately provide IWMC with written notice thereof, together with a copy of any statement, report, notice, registration, application, permit, business plan, licence, claim, action, or proceeding given to, or received from, any governmental authority concerning the Environmental Damage and Degradation.
- (d) The Contractor's obligations set forth in this Section 4.9 are in addition to, and not a substitute for, the indemnity provisions set forth in this Agreement at Section 12 and shall survive the termination of the Agreement.
- (e) Unless otherwise expressly required or permitted under this Agreement, the Contractor will not, and will ensure that any of its subcontractors do not:
 - (i) install, use or store on any real property, other than real property owned by the Contractor, any materials, equipment or apparatus, the installation, use or storage of which is likely to cause, or in fact causes, the generation, accumulation or migration of any Hazardous Substance in contravention of any Applicable Laws;
 - (ii) without limiting the generality of Section 4.9(e)(i), cause any real property, other than property owned by the Contractor, to become a contaminated site in contravention of Applicable Laws; and,
 - (iii) without limiting the generality of either Section 4.9(e)(i) or (ii), cause or permit any Hazardous Substance to be spilled or released in, on, under, from or about any real property, other than real property owned by the Contractor, including, without limitation, through any plumbing or sanitary sewer system.

4.10 Reporting

- (a) In addition to any reporting obligations contained in Section 12 of Schedule B – Work Specification, the Contractor shall immediately report in writing to IWMC, taking into account the method of reporting and the required recipient of the report as set forth in Section 12 of Schedule B – Work Specification, any violation of Applicable Laws, any spills of vehicle fluids, any motor vehicle accidents involving the Contractor's collection equipment or any other material issue that arises during the provision of the Work. Any complaints made by Residents in connection with the Contractor's performance of the Work shall be reported using the Daily Drivers Report as set forth

in Section 12 of Schedule B – Work Specification.

- (b) The Contractor shall maintain the reporting and records, as set forth in Section 12 of Schedule B – Work Specification for a period of not less than 2 years after the Expiry Date, the termination of this Agreement or the termination or expiry of an Extension Term(s).

4.11 Representatives and Key Personnel

(a) **Representatives**

- (i) The Contractor’s single point of contact with respect to the Work, the Contractor’s “**Solid Waste Collection Representative**”, shall be the person set forth as such in the Contractor’s Proposal and such person shall be a Key Individual.
- (ii) IWMC shall, at the time of executing this Agreement, advise the Contractor of IWMC’s Solid Waste Collection Representative.
- (iii) Either Party may at any time and in its own discretion by notice to the other Party, change the person appointed as the Party’s Solid Waste Collection Representative. If for any reason a Solid Waste Collection Representative is unable or unwilling to continue, then the Party will immediately appoint a replacement Solid Waste Collection Representative. If at any time IWMC, acting reasonably, objects to the Contractor’s Solid Waste Collection Representative, then the Contractor will use reasonable commercial efforts to replace its Solid Waste Collection Representative with a person reasonably acceptable to IWMC.
- (iv) A Party’s Solid Waste Collection Representative will have full authority to act on behalf of the Party with respect to its obligations in accordance with this Agreement, including receiving any explanations, instructions or directions from the other Party or giving any review, monitoring, acceptance, approval or confirmations to the other Party. Notwithstanding the above, a Party’s Solid Waste Collection Representative will not have the authority to execute or agree to any amendments, to authorize a Change, or to give any waivers of this Agreement.

(b) **Key Individuals**

- (i) Section 2.5(b)(i) and Section 2.5(b)(ii) of Schedule B – Work Specification sets forth the positions, and details the respective roles, of the Contractor’s personnel (the “**Key Individuals**”), as proposed by the Contractor in the Contractor’s Proposal, that the Contractor will utilize in performing the Work.
- (ii) With respect to Key Individuals:

- (1) the Contractor will use all reasonable efforts to retain the Key Individuals to perform the Work for the Operational Term and an Extension Term(s) and, in particular, will, for the duration of the Operational Term, and an Extension Term(s), as applicable to the relevant role, require such person to devote the proportion of his or her time necessary to fully perform the role in accordance with this Agreement;
- (2) if the Contractor considers it necessary to replace a Key Individual, due to reasons such as resignation or termination, the Contractor will use all reasonable efforts to retain a comparable replacement, the Contractor shall provide IWMC with relevant information on the proposed replacement, and the Contractor shall consult with IWMC before finalizing the appointment of such replacement.
- (3) if IWMC determines, acting reasonably, that a Key Individual's continued involvement with the project has a reasonable likelihood of causing a risk to public safety or damage to the reputation of IWMC or its programs including the "Waste Watch Program", then IWMC shall notify the Contractor (including a detailed explanation of the reasons for such determination), and, without prejudice to the Contractor's right to dispute such determination under the dispute terms of this Agreement, within 30 days of receipt by the Contractor of such notice, the Contractor shall use all reasonable efforts to make a replacement. The Contractor shall provide IWMC with relevant information on the proposed replacement and the Contractor shall consult with IWMC before finalizing the appointment of such replacement.
- (4) With respect to any replacement personnel to be hired by the Contractor in Section 4.11(b)(ii)(2) and Section 4.11(b)(ii)(3), the Contractor shall not replace a Key Individual without the prior written consent of IWMC, which consent shall not be withheld or delayed where the proposed replacement is suitably qualified and experienced and of equal or better quality and experience than the individual being replaced.

(c) **Employees and Training**

- (i) The Contractor acknowledges and agrees that it shall, at all times during the performance of the Work, ensure that the Contractor's employees, including but not limited to supervisors, administrative personnel (clerks), drivers and collectors, act in a courteous manner in all dealings with Residents of Serviced Units, the public and IWMC. Inquiries from Residents of Serviced Units and the public that are directed to drivers and collectors during the performance of the Work shall be received by employees in a courteous manner and responded to with basic information regarding the Work and any further inquiries are to be directed to IWMC's Customer Service Center.
- (ii) The Contractor shall ensure that its employees:

- (1) collect and transport all appropriately placed Source-Separated Solid Waste and Organics;
 - (2) are properly trained by the Contractor to drive and operate the collection vehicle to which the employee is assigned;
 - (3) understand and can follow collection vehicle routes and collection schedules;
 - (4) apply, as provided by IWMC, policies related to education, tagging/stickering, rejection, and basic Source-Separated Solid Waste and Organics information and reporting;
 - (5) possess a valid driver's license of the appropriate class;
 - (6) wear the appropriate attire and personal protective equipment while performing the Work;
 - (7) are trained in the Contractors' diversity and inclusion policy;
 - (8) are trained in the Contractor's health and safety protocols for the Collection and Transportation of Source-Separated Solid Waste and Organics; and,
 - (9) operate the Contractor's Collection and Transportation equipment in a safe, effective and skilled manner.
- (iii) In the event that IWMC receives complaints from members of the public, or Residents of Serviced Units, regarding the performance or conduct of a Contractor's employee, IWMC shall advise the Contractor of such complaint. It shall then be the responsibility of the Contractor to follow up on the complaint and advise IWMC of the outcome.
- (iv) The Contractor shall be responsible to provide training for those employees who carry out the Work in accordance with the training requirements set forth in Sections 2.5(b)(i), 2.5(b)(ii) and 11.1(a)(i)(6) of Schedule B – Work Specification. Such training shall be updated annually for all employees. The training for drivers and collectors shall include information on diversity and inclusion, IWMC's mandatory Source-Separated Waste Watch program, health and safety requirements, basic customer service requirements including how to respond to inquiries from the public, and how to apply IWMC's policies and requirements related to education of the public, information gathering and reporting and the tagging/stickering and rejection of Source-Separated Solid Waste and Organics.
- (v) Upon reasonable request, the Contractor shall submit its training plan and records to IWMC

for review. IWMC may provide the Contractor with reasonable changes to the training plans and the Contractor shall incorporate such changes into the training plans.

- (vi) The hourly rate of wages to be paid by the Contractor, to employees performing the Work shall be not less than the minimum wage of the Province of Prince Edward Island.

4.12 IWMC's Access to the Work

The Contractor shall permit authorized and designated representatives of IWMC to have full and complete access to the Work and permit such representatives to conduct periodic monitoring as set forth in Section 10.1 of Schedule B – Work Specification, and to examine, inspect, approve or reject any equipment, procedures and workmanship of the Contractor deemed inappropriate by IWMC, acting reasonably. Such access includes the right to be a passenger in the Contractor's collection vehicles for the purpose of inspecting or surveying the Work, subject to IWMC providing 24 hours' notice to the Contractor and subject to IWMC's staff complying with the appropriate occupational health and safety standards of the Contractor related to the Work.

4.13 Retention of Source-Separated Solid Waste and Organics

Source-Separated Solid Waste and Organics placed for collection by the Residents of Serviced Units shall not be retained by the Contractor. All Source-Separated Solid Waste and Organics must undergo Collection and Transportation in accordance with this Agreement.

4.14 Health, Safety and Security

- (a) With respect to health, safety, and security of the Contractor's performance of the Work:
 - (i) The Contractor has the authority and the obligation under this Agreement to assume the primary responsibility for creating and maintaining a secure, safe and healthy workplace.
 - (ii) As part of the provision of the Work, the Contractor will undertake all necessary and prudent actions in respect of occupational health and safety that may pertain to the performance of the Work and shall produce such reports from time to time as set forth in this Agreement and as IWMC may reasonably require verifying the Contractor's efforts in respect of health and safety during the performance of the Work. The Contractor shall become familiar with, and implement any requirements of IWMC's, or its Contractors, health and safety policies which shall be updated by IWMC or its Contractors, from time to time and available to the Contractor by request, including, but not limited to, those health and safety requirements in place at Receiving Facilities.
 - (iii) The Contractor will maintain the security and safety of its equipment, and facilities from which it operates, in accordance with Applicable Laws and at a level consistent with

recognized, good industrial practices. The Contractor will give all notices (with a copy to IWMC) as such notices are required by Applicable Laws.

- (iv) The Contractor will take all reasonable precautions with respect to security and safety during the performance of the Work including providing all reasonable protection and preventative measures to prevent damage, injury or loss by reason of, or related to, the performance of the Work to: (a) all employees performing the Work, invitees and all other persons for whom the Contractor may be responsible by Applicable Laws; (b) all materials and equipment under the care, custody or control of the Contractor; and, (c) public and private property including, but not limited to, trees, walkways, driveways, pavement, roadways, utilities, buildings and other structures.
- (v) The Contractor will establish and enforce all reasonable safeguards for safety and protection, including ensuring all its employees utilize necessary personal protective equipment, posting danger signs and other warnings against hazards and establishing and implementing reasonably appropriate efforts to enforce safety regulations.
- (vi) The Contractor will designate at least one qualified and responsible employee, and notify IWMC of such individual, whose main role shall be the supervision of the Contractor's health, safety and security during the Term of this Agreement and the coordination of such activities as shall be necessary with federal, provincial, and local officials.
- (vii) The Contractor will operate its equipment, including the operation of all collection vehicles, in a manner consistent with the manufacturer's safety recommendations.
- (viii) No later than 90 days prior to the Operations Effective Date, the Contractor shall file with IWMC a copy of the Contractor's health and safety procedures and protocols and shall provide IWMC with any updates to those procedures or policies that may occur from time to time during the Term of the Agreement. At a minimum, the Contractor's safety procedures and protocols shall include identification of safety hazards anticipated during the performance of the Work, potential solutions to those safety hazards and work procedures that address the safety hazards. IWMC neither approves nor accepts responsibility or liability for the Contractor's safety procedures and protocols.
- (ix) Should IWMC become aware of a health, safety or security matter with respect to the Contractor's provision of the Work, IWMC may, in progressive order:
 - (1) identify the issue verbally and in writing to the Contractor's Solid Waste Collection Representative;
 - (2) inform the applicable governmental authority in writing; and,

- (3) if determined by IWMC in its sole discretion, suspend the Contractor's provision of the Work or terminate this Agreement, in accordance with its terms.

Depending upon the nature or seriousness of the health, safety or security matter, IWMC may bypass any or all of the above steps set forth in Section 4.14(ix) and, in accordance with the terms of this Agreement, advise the Contractor of the termination of this Agreement.

4.15 Schedule for the Work

Weekly Schedule:

The current collection days (the "**Weekly Schedule**") for the Eastern Kings Region are Monday to Friday.

- (a) No later than 60 days prior to the Operations Effective Date, the Contractor shall provide IWMC with:
 - (i) a draft schedule for the Work (the "**Work Schedule**") which it anticipates commencing on the Operations Effective Date. The draft Work Schedule shall provide an overview of the Contractor's expected route for each collection vehicle for each day, including the starting time and starting point for each collection vehicle for each collection day over the 5-day collection week. The draft Work Schedule shall also provide an overview of the Contractor's route and plan to collect Special Collections.
- (b)
 - (i) The Contractor, upon establishing a regular daily Collection and Transportation routine after the Operations Effective Date, shall submit to IWMC a final Work Schedule. This final Work Schedule shall be submitted no later than 30 days after the Operations Effective Date. This final Work Schedule shall be maintained for the Operational Term, and any Extension Term(s), subject to amendments which IWMC and the Contractor may mutually agree to in writing, each acting reasonably, during the Term or an Extension Term(s), as the case may be.
 - (ii) Any requests to change the Weekly Schedule, as set forth in Section 4.15(a), must be submitted in writing no less than 120 days prior to the date on which the Contractor wishes to implement the change. The Contractor shall communicate with IWMC regularly throughout the Operational Term or an Extension Term(s) with respect to potential changes to the Weekly Schedule. All requests for changes to the Weekly Schedule shall be reviewed by IWMC and the granting of such change shall be at the sole, but reasonable, discretion of IWMC. Upon IWMC's approval of a change to the Weekly Schedule, IWMC and the Contractor shall, both Parties acting reasonably, determine an appropriate timeframe for the implementation of such changes and IWMC shall determine the appropriate public notification program to which the Contractor will agree in order for the change to go forward, as set forth in 4.15(b)(iii).

- (iii) For any change that is approved as set forth in 4.15(b)(ii) the Contractor shall be solely responsible for all costs associated with advertising such change to the public which will be impacted by such change. At a minimum, the Contractor must provide a form of “door-to-door” notice such as handouts or “door knockers” to all Serviced Units affected by such change. IWMC will assist the Contractor with communication of the changes by performing such tasks as the development and presentation of online communications to the public. The Contractor shall be responsible, at its sole cost and expense, for the Collection and Transportation of any Source-Separated Solid Waste or Organics placed incorrectly for collection by the public or Serviced Units, for a period of two (2) collection cycles after the change in collection schedule has been implemented.

4.16 Performance Security

- (a) The Contractor shall obtain, and maintain, or cause to be obtained and maintained, at no cost or expense to IWMC, and from financially sound surety companies, Schedule I or Schedule II Banks or other financially sound providers of security in accordance with Section 4.17(b), all such security having such value as set forth in this Section 4.16(a)(i) (the “**Performance Security**”). The Performance Security shall include, at a minimum, the following security arrangements and values:
 - (i) from the Effective Date until this Agreement is terminated in accordance with its provisions, or expires in accordance with its provisions, an irrevocable letter of credit or performance bond, or combination thereof, satisfactory to IWMC acting reasonably, renewable annually, or issued each year of the Term and any Extension Term(s) and, in the amount of ten (10) percent of the total bid price for the contract during the Operating Term, and in the amount of fifty (50) percent of the total bid price for year five (5) of the Operating Term for each year of the Extension Term(s).
- (b) All Performance Security required to be obtained and maintained by the Contractor pursuant to this Agreement shall:
 - (i) be submitted in an original, electronic format and must be viewable, printable and storable by IWMC;
 - (ii) be verifiable by IWMC (with the Schedule I Bank or Schedule II Bank or surety provider) with respect to the totality and wholeness of the form of the Performance Security, including, but not limited to: (a) the content; (b) all digital signatures; and, (c) all digital seals;
 - (iii) for any bond, name “IWMC” as the Obligee and be signed, sealed, and dated by both the Contractor and the surety provider;

(iv) for any bond, be verifiable by IWMC immediately, or at any time during the life of the bond, with no requirement for passwords or fees and the results of such verification must provide a clear, immediate and printable indication of the verification's success or failure;

(v) issued by,

1. a Schedule I Bank;
2. a Schedule II Bank with the prior written approval of IWMC; or
3. a surety provider; and

such Schedule I Bank or Schedule II Bank or surety provider shall have a minimum senior, unsecured long term credit rating of not less than A- (with any outlook) or equivalent from one of (and no rating less than A- (with any outlook) or equivalent from any other of) Standard & Poor's, Moody's, DBRS (formerly known as Dominion Bond Rating Service) or Fitch Ratings (or any other major credit rating agency approved for the purposes of this Section 4.16 by IWMC, who may grant or decline such approval in its absolute discretion);

(vi) callable at such Schedule I Bank's or Schedule II Bank's counters in Charlottetown, Prince Edward Island if such Performance Security is issued by a Schedule I Bank or Schedule II Bank;

(c) In the event that any of the ratings as described above of such Schedule I Bank, Schedule II Bank or surety, that has issued the Performance Security falls below A-, the Contractor shall, no later than 21 days after the rating of such bank has fallen below A-, replace the Performance Security, with a replacement, substantially in the form required by this Section 4.16, for the same amount and issued by a Canadian chartered bank or surety provider with a minimum rating of A-. In the event that no Canadian chartered bank or surety provider has a minimum rating of at least A-, IWMC will, by notice to the Contractor, revise the minimum rating requirement to reflect the highest rated Canadian chartered bank, or a lower rating, in IWMC's sole and absolute discretion. For clarity, IWMC will exercise its sole and absolute discretion in relation to this Section 4.16(c) only in cases where it will revise the minimum rating requirement to a lower rating.

(d) All Performance Security shall be in form and substance acceptable to IWMC, acting reasonably, and HST shall be excluded from the amount of Performance Security set forth in Section 4.16(a)(i).

(e) It shall be a condition of all Performance Security that each letter of credit, guarantee, or similar financial instrument, must be renewed annually or reissued each year, without amendment, and from year to year for the Term, and for the Extension Term(s), as applicable.

4.17 Maintenance of Private Property

- (a) The Contractor is responsible, in accordance with the process set forth in Section 11.1 of Schedule B - Work Specification to investigate and respond to complaints and inquiries from IWMC and the public concerning the Contractor's performance of the Work.
- (b) The Contractor is responsible to repair all damage caused to property owned by IWMC or its Contractors (e.g., PEI Energy Systems) or property owned by residents or owners of the Serviced Units as a result of the Contractor's performance of the Work. Such repairs are to be completed within a reasonable period of time as determined jointly by IWMC and the Contractor, both parties acting reasonably. If the Contractor fails to make such repairs within the required time period, IWMC may make such repairs and subsequently invoice the cost to the Contractor or suspend or terminate this Agreement in accordance with its terms. Any urgent or safety related repairs requiring immediate attention will be commenced by the Contractor within 24 hours of the Contractor becoming aware of the need for such repairs.
- (c) IWMC is not liable for damages, and will not respond to any claims for damages, to private property as a result of the Contractor carrying out the Work. However, IWMC will coordinate any investigations and responses to inquiries and complaints from the public regarding disputed property damages. When necessary, IWMC will provide the Contractor's contact information, which may include Contractor's insurance information, to the owner of the private property and/or the owner's insurance company and advise the owner to pursue any claims for damages directly with the Contractor.

5. Obligations of IWMC

5.1 IWMC Representations and Warranties

IWMC represents and warrants to the Contractor, as of the Effective Date, that:

- (a) IWMC has full power and capacity to enter into, carry out the transactions contemplated by and duly observe and perform all its obligations contained in this Agreement and all other documents, instruments and agreements required to be executed and delivered by IWMC pursuant to this Agreement;
- (b) the execution and delivery of this Agreement and all documents, instruments and agreements required to be executed and delivered by IWMC pursuant to this Agreement, and the completion of the transactions contemplated by this Agreement, have been duly authorized by all necessary action on the part of IWMC, and this Agreement has been duly executed and delivered by IWMC and constitutes a legal, valid and binding obligation of IWMC enforceable in accordance with its terms, subject to limitations by bankruptcy, insolvency, liquidation, reorganization, reconstruction and other similar laws of general application affecting the enforceability of remedies and rights of

creditors and subject to availability of equitable remedies such as specific performance and injunction that are in the discretion of a court;

- (c) to the extent the IWMC's representative, or its Disposal Manager, has knowledge, there are no facts or information relating to the Work which IWMC has intentionally not disclosed to the Contractor and which, if learned by the Contractor, would reasonably be expected to materially affect the Contractor's evaluation of the risks the Contractor is assuming pursuant to this Agreement.

5.2 Public Education

IWMC will:

- (a) conduct and maintain various public outreach and educational programs from time to time throughout the Term informing Residents of the proper Source-Separated Solid Waste and Organics to be placed for Collection and Transportation; and,
- (b) from time to time, reasonably require that the Contractor assist IWMC with public education initiatives that may result from IWMC's efforts set forth in Sections 5.2(a). Such assistance may be in the form of the Contractor's personnel time and such support from the Contractor shall be agreed upon in writing by IWMC and the Contractor prior to the undertaking of any public education initiative. Such assistance shall not limit the Contractor's obligations as set forth in Section 5.13 and 5.14 of Schedule B – Work Specification.

5.3 IWMC Personnel

When attending at a site of the Contractor, or when on or in any equipment belonging to the Contractor, or when accompanying the Contractor for inspection purposes in accordance with this Agreement, IWMC shall ensure that its personnel are familiar with, and abide by, the safety requirements of the Contractor. IWMC employees shall wear the appropriate personal protective equipment when required to do so.

5.4 Authority of IWMC

- (a) IWMC's Solid Waste Collection Representative shall have the authority to interpret the terms and conditions and requirements of the Agreement, including the Contractor's performance of its obligations as set forth in the Agreement, including the Work Specifications, to ensure the Work is performed to the satisfaction of IWMC.
- (b) Any disputes with respect to the judgment of IWMC's Solid Waste Collection Representative shall be addressed in accordance with the dispute resolution procedure set forth in Section 18 of this Agreement.

5.5 No Exclusivity

IWMC reserves the right to

- (a) enter into an agreement with any other contractor in order for that contractor to:
 - (i) perform a portion of the Work; or,
 - (ii) perform services similar to the Work as such Work is expressly set forth in this Agreement and Schedule B – Work Specification; or,
- (b) use IWMC’s own resources to:
 - (i) perform a portion of the Work; or
 - (ii) perform services similar to the Work as such Work expressly set forth in this Agreement and Schedule B – Work Specification, and

IWMC and the Contractor acknowledge and agree that it is the intention of IWMC to enter into such agreement with another contractor or to perform the services itself, only in cases where IWMC has provided the Contractor with an opportunity to perform the required portion of the Work, or the services that are similar to the Work as such Work is expressly set forth in this Agreement and Schedule B – Work Specification and the Contractor has unwilling or has otherwise not done for whatever reason within a reasonable period of time. IWMC and the Contractor also acknowledge and agree that IWMC may enter into an agreement with another contractor to perform services, or perform services itself, without the need for notifying the Contractor, if such services are not, as determined solely but reasonably by IWMC, similar to the Work.

6. **Material Rights**

6.1 IWMC Ownership of Material Rights

- (a) All findings, data, surveys, research, working papers, drawings, spreadsheets, evaluations, plans, processes, systems, databases and documents, regardless of storage format or whether in draft or final form that are collected, created or produced by the Contractor in the performance of this Agreement (collectively the “**Materials**”) are the exclusive property of IWMC. All intellectual property rights, including patents, copyrights, trademark and industrial design in the Materials, with the exception of any pre-existing intellectual property rights of the Contractor therein, are the sole property of IWMC, are hereby irrevocably assigned by the Contractor to IWMC and the Contractor herewith waives all moral rights in those Materials.
- (b) All research reports, surveys, findings, data and other information comprising the Materials are

Confidential Information of IWMC and are subject to the provisions of Section 16 of this Agreement.

- (c) IWMC reserves the right, in its sole discretion, to publish or release, in whole or in part, or to refrain from publishing or releasing, any research, reports, information, audio visual materials, information or data produced by the Contractor in the performance of the Work under this Agreement.
- (d) The Contractor shall ensure that IWMC has all licenses that are needed for any software that IWMC will require to lawfully continue using all Materials or deliverables that the Contractor has agreed to provide as part of the Work.
- (e) The Contractor hereby grants to IWMC a perpetual, non-exclusive license to use any computer software or designs of a generic nature, to which the Contractor holds copyright, and that may be included in any Materials, deliverable or work product comprising any part of the Work delivered to IWMC under this Agreement.
- (f) If IWMC requests, the Contractor shall provide or return to IWMC all Materials in its possession and/or destroy all copies thereof.

7. Invoicing and Payments

7.1 Invoicing by the Contractor

- (a) The Contractor shall submit to IWMC a monthly invoice for the Work performed during the month that just ended. The monthly invoice shall include, at a minimum, the following information:
 - (i) the authorized purchase order, contract number or applicable reference number from IWMC;
 - (ii) an itemized list showing the appropriate unit price for each collection type and the number of serviced units or other services for which the Work was performed for the month;
 - (iii) the total amount invoiced for the month, plus applicable HST;
 - (iv) the Contractor's contact information for the person to whom IWMC should direct questions regarding the contents of the invoice, if such person is not the Contractor's Solid Waste Collection Representative;
 - (v) the Contractor's HST registration number; and,
 - (vi) all such other information as reasonably requested by IWMC from time to time for inclusion

in an invoice.

- (b) The unit prices to be invoiced monthly by the Contractor shall be based on the prices from the Cost Proposal submitted by the Contractor and accepted by IWMC. For clarity, prior to the commencement of the Work and for each new contract year, IWMC will provide the Contractor with a Monthly Payment Table (Table A4) for the year, as set forth in Schedule C, which shall show the applicable monthly unit prices and the applicable number of serviced units by collection type to be used on the monthly invoice, which will have been adjusted for increases and/or decreases from the prior year's numbers.

7.2 Payment by IWMC

- (a) Subject to the Contractor meeting the requirements for each of the payments set out in this Agreement, including the requirements of Schedule B – Work Specification, IWMC, in accordance with the terms and conditions of this Agreement will pay the Contractor the amounts as set forth in Schedule A.
- (b) The Contractor and IWMC acknowledge and agree that the per unit Prices set forth in Schedule A are subject to change during the Term or an Extension Term(s) as set forth in Schedule A.
- (c) Other than the payments expressly provided for in this Agreement, the Contractor will have no right to any further payment from IWMC in connection with the Work or otherwise relating to the Collection and Transportation of Source-Separated Solid Waste and Organics.
- (d) Except as expressly set out in this Agreement, IWMC shall not be obligated to pay any costs, fees or charges in relation to the Work. The Contractor is solely responsible for paying all costs, fees and charges of any nature whatsoever required to complete the Work, except for:
 - (i) Disposal fees at IWMC's final disposal facilities for the tonnages of waste and organic materials disposed of;
 - (j) the costs, fees and charges of IWMC's personnel, consultants and professional advisors; and,
 - (ii) costs, fees, charges, or payments expressly to be made by IWMC under the provisions of this Agreement.
- (e) The Contractor acknowledges and agrees that it is responsible for Collection and Transportation at any additional Serviced Units constructed in the Region after commencement of the Work. The Contractor also acknowledges and agrees that the number of Serviced Units for which the Contractor is required to provide Collection and Transportation may increase or decrease during the Operational Term of the Agreement, or an Extension Term(s). An adjustment to reflect the

increase or reduction of the number of Serviced Units shall be made and paid by IWMC to the Contractor as set forth in Schedule A.

- (f) Conforming, undisputed invoices will be paid within 30 days following the receipt of the invoice by IWMC. Payments will be administered through IWMC's electronic payment process. Upon execution of this agreement the Contractor shall send its invoices to acctspay@iwmc.pe.ca.
- (g) IWMC will not be considered in default of its requirement to pay the Contractor as set forth in this Section 7, if the payment process is delayed due to the Contractor's failure to comply with the requirements of this Section 7.
- (h) No payment by IWMC to the Contractor shall be, or construed to be, an acceptance or approval by IWMC of incomplete, defective or improper performance by the Contractor of any of its obligations under this Agreement or operate to relieve the Contractor from the performance of any of its obligations that have not been performed in accordance with the requirements set out in this Agreement, including those in Schedule B – Work Specification.
- (i) The Contractor acknowledges and agrees that IWMC may set-off any amount due or owing to the Contractor pursuant to this Agreement against any amounts the Contractor owes to IWMC.
- (j) Annually, at the end of each contract year, monthly payment amounts made by IWMC in accordance with Schedule A and the Monthly Payment Table shall be reconciled by IWMC and provided to the Contractor. The reconciliation will compare the sum of the monthly payments for the prior year to a calculated Annual amount owing to the Contractor for the work, which will include an adjustment for the number of serviced units and any other items as set out in Schedule A and this agreement. The reconciliation will show that either IWMC owes the Contractor a remaining amount, or that the Contractor owes back to IWMC a remaining amount for the Work performed for the prior year. The Contractor shall have 30 days from the date of receipt of the reconciliation statement to advise IWMC of any issues the Contractor may have with such reconciliation. If IWMC and the Contractor cannot resolve any reconciliation issues within 60 days after the reconciliation was provided to the Contractor, the dispute may be addressed in accordance with the Dispute Resolution Procedure as set forth in Section 18, at the election of either IWMC or the Contractor. Once agreed, IWMC will pay the amount owing to the Contractor or, in the case where an amount is owing to IWMC by the Contractor; such amount will be deducted from payment of the next monthly invoice(s) from the Contractor until settled.

7.3 Fuel Escalation

The Parties acknowledge and agree that during the Operational Term and any Extension Term(s) the impact on the price per unit to address a change in the price per litre of diesel fuel ("**Diesel Fuel Price Change**") will be addressed as follows:

- (a) The Benchmark Diesel Fuel Price for the purposes of this Agreement is \$____per litre as was confirmed by an Addendum to the RFP submission process on _____ (date two weeks prior to submission deadline).
- (b) IWMC will determine the price of diesel fuel (in Cdn \$/litre) that is equal to 5% greater than the Benchmark Diesel Fuel Price (the “**Diesel Fuel High Target**”) and will determine the price of diesel fuel that is equal to 5% less than the Benchmark Diesel Fuel Price (the “**Diesel Fuel Low Target**”).
- (c) IWMC will determine a number of litres of diesel fuel required monthly to complete the Bi-Weekly Organics/Waste collection by the Contractor as follows:
- (i) The Contractor shall, within 30 days of the commencement of the term of this Agreement provide to IWMC a completed Monthly Diesel Fuel Amount Table - Schedule D for the Region to allow IWMC to determine an amount for the litres of fuel consumed in a month.
 - (ii) IWMC will independently verify the information in the table before accepting it. Any disagreement will be subject to the Dispute Resolution Mechanism set forth in Section 18.
 - (iii) To determine the litres of monthly fuel consumption the total kilometers travelled will be divided by 4.5 (kms) and multiplied by 3.8 (litres) to determine the total litres per week of diesel fuel used in the performance of the weekly collection for the Region. The total amount of weekly litres of diesel fuel will then be multiplied by 52 and divided by 12 to determine the Monthly Diesel Fuel Amount in litres.
- (d) At the end of each month of the Operational Term or Extension Term(s), the Contractor will determine the price for diesel fuel used for the month using the price set forth by Island Regulatory and Appeals Commission for the 15th day of that month (the “**Monthly Diesel Fuel Price**”). The Contractor will then compare the Monthly Diesel Fuel Price for the month to the Diesel Fuel High Target and the Diesel Fuel Low Target.
- (e) If the Monthly Diesel Fuel Price is higher than the Diesel Fuel High Target, then a Diesel Fuel Price Change shall occur and the Contractor shall invoice the amount, calculated in Section 7.3(f) to IWMC (the “**Contractor Diesel Fuel Payment**”). If the Monthly Diesel Fuel Price is lower than the Diesel Fuel Low Target, then a Diesel Fuel Price Change shall occur and the Contractor shall provide a credit invoice to IWMC, calculated in Section 7.3(g) (the “**IWMC Diesel Fuel Payment**”).
- (f) To determine the Contractor Diesel Fuel Payment, the Contractor shall calculate the difference between the Monthly Diesel Fuel Price for the month and the Diesel Fuel High Target. This difference shall then be multiplied by the Monthly Diesel Fuel Amount (litres) to determine the Contractor Diesel Fuel Payment.
- (g) To determine the IWMC Diesel Fuel Payment, the Contractor shall calculate the difference

between the Monthly Diesel Fuel Price for the month and the Diesel Fuel Low Target. This difference shall then be multiplied by the Monthly Diesel Fuel Amount (litres) to determine the IWMC Diesel Fuel Payment.

- (h) The amount determined under 7.3(f) or (g) shall be subject to HST and shall be included as an adjustment on the Monthly invoice from the Contractor, supported by an attachment that shows the calculation to arrive at the adjustment.

7.4 Final Payments

- (a) Subject to the termination provisions of the Agreement, if the Agreement expires at the end of the Term, a final payment from IWMC to the Contractor shall be made 60 days after the completion of the Work, in accordance with this Agreement.
- (b) Notwithstanding Section 7.4(a), final payment shall not be made, and any Performance Security shall not be returned to the Contractor or the holder of such Performance Security, until the following, written certificates, appropriately authorized, have been filed with IWMC:
 - (i) a certificate stating that all payments resulting from the Agreement for which the Contractor is liable to pay to IWMC or to the sub-contractors have been paid;
 - (ii) a certificate stating that the Contractor has paid all assessments required by the Worker's Compensation Board in respect to this Agreement; and,
 - (iii) a certificate stating that all Work required during the Term by IWMC in accordance with the Agreement have been fully performed and have been paid in full by IWMC.

8. Insurance

8.1 Insurance Coverage

- (a) Without restricting the generality of the Contractor's indemnification pursuant to Section 12 of the Agreement, the Contractor shall obtain, pay for, maintain in force and renew as required throughout the Term and any Extension Term(s), the insurance coverages listed below in Section 8.2 (the "**Required Insurance**") with respect to the performance of the Contractor's obligations under the Agreement.
- (b) Neither compliance nor failure to comply with the insurance provisions of this Agreement shall relieve the Contractor of its liabilities and obligations under this Agreement.
- (c) The Required Insurance policies shall name Island Waste Management Corporation as an additional insured.

8.2 Required Insurance

(a) The Required Insurance is as follows:

- (i) commercial general liability and property damage insurance, ("**CGL Insurance**") with limits of not less than \$5,000,000.00 per occurrence for bodily injury, death, and for property damage including loss of use thereof, with a deductible not exceeding \$5,000 and the CGL Insurance shall include, but not limited to, coverage for:
 - (1) owner's and contractor's contingent liability with respect to the operation of persons, firms and corporations having a contract for the execution of a part or parts of the Work included in this Agreement;
 - (2) products and completed operations liability;
 - (3) blanket contractual liability and specific contractual liability covering this Agreement and any amendments hereto;
 - (4) cross liability;
 - (5) contingent employer's liability;
 - (6) personal injury liability; and,
 - (7) non-owned automobile liability, including, Municipality-owned vehicles or trailers, if such vehicles or trailers are attached to Contractor's vehicles.
- (ii) automobile liability insurance for all vehicles engaged in the performance of the Work pursuant to this Agreement ("**Automobile Insurance**"), with PLPD limits of not less than \$5,000,000.00 per occurrence for bodily injury, including death, and property damage without deductible; including owner's form automobile policy providing third Party liability and accident benefits insurance and covering licensed vehicles owned or operated by or on behalf of the Contractor;
- (iii) environmental impairment liability insurance ("**Environmental Insurance**") covering sudden and accidental pollution or losses arising out of, relating to, resulting from or in connection with the Collection and Transportation of the Source-Separated Solid Waste and Organics pursuant to this Agreement as well as third Party bodily injury and property damage with limits of not less than \$5,000,000 per occurrence with deductible not exceeding \$10,000; and
- (iv) any additional insurance that a prudent contractor, in Canada, performing services similar

to the Work, and to standards similar to those set forth in this Agreement, would obtain and maintain for the duration of the Term or the Extension Term(s).

- (b) The Required Insurance may be met through any combination of primary insurance and excess insurance, so long as the total amounts carried combine to meet the minimum amounts required as set out in Section 8.2(a) of this Agreement.
- (c) The Contractor shall conduct periodic reviews of the Contractor's equipment used in the performance of the Work at not less than every six (6) months during the Operational Term of the Agreement or an Extension Term(s), to determine if the policy limits set forth in the Required Insurance policies are correct or if they require changes. The Contractor shall update the policy limits used in the Required Insurance policies if reasonably required by the review.
- (d) Certificates of proof of insurance of the Required Insurance shall be submitted to IWMC on or prior to the Effective Date. Approval by IWMC, or by any other party on its behalf, of any certificate of insurance submitted by the Contractor, or by the Contractor on behalf of a subcontractor, shall in no way relieve the Contractor of its obligations to provide, and to cause its subcontractors to provide, the Required Insurance, nor shall it imply that the policies are in accordance with the terms of this Agreement. It shall be the responsibility of the Contractor to ensure that all Required Insurance policies shall be renewed at least one month prior to expiry date and certificates of insurance for such renewals shall be filed with IWMC prior to inception date of the renewals.
- (e) The Required Insurance will not be amended or cancelled by the Contractor until 45 days after written notice of such intended amendment or cancellation has been delivered to IWMC and such change or amendment has been approved by IWMC.
- (f) The Contractor, and each subcontractor, shall obtain, at its own cost, any additional insurance which it may be required by Applicable Law to obtain or which it may consider necessary for the performance of the Work.
- (g) If the Contractor, or any subcontractor, fails to obtain any Required Insurance or to furnish to IWMC a certificate of insurance for any of the Required Insurance coverages required to be obtained in accordance with this Agreement or if, after obtaining such Required Insurance or furnishing such certificate of insurance, the Required Insurance policy lapses, is cancelled, or is materially altered, then in every such case IWMC may, without obligation to do so, obtain and maintain such Required Insurance in the name of the Contractor or a subcontractor. The cost thereof shall be payable by the Contractor to IWMC on demand and IWMC may, at its election, deduct the cost thereof from any monies which are due or may become due to the Contractor.
- (h) The Contractor shall be responsible for the cost of the Required Insurance, including any deductibles, without payment or reimbursement from IWMC, and, to the extent any increase in

the amount of any premium payable by the Contractor in respect of any policy of the Required Insurance is directly attributable to the negligent acts or omissions of IWMC during the Term of the Agreement, then IWMC shall reimburse to the Contractor the amount of such increase.

- (i) The Required Insurance policies will be primary to any other coverage or form of recovery or restitution available to IWMC such as, but not limited to, the Province of Prince Edward Island Self Insurance and Risk Management Fund and the policies shall so state this or be endorsed to this effect.
- (j) The Required Insurance policies will preclude subrogation claims by an insurer against any Party insured thereunder.
- (k) All Required Insurance policies shall be in the Insurance Bureau of Canada extant standard form or another equal or similar form reasonably satisfactory to IWMC and shall be with insurers licensed to do business in the province of Prince Edward Island.
- (l) IWMC shall retain at all times the right, but not the obligation, to review the originals of any Required Insurance policies in its office at any reasonable time. Any such review done by IWMC, or on its behalf, shall not imply that the terms of this Agreement have been fulfilled.
- (m) If IWMC, acting reasonably, requires:
 - (i) the amount of the Contractor's Required Insurance coverage be increased;
 - (ii) any Required Insurance policy is to be extended in respect of this Work; or
 - (iii) the Contractor or subcontractors obtain other special insurance;

then the Contractor shall obtain, or cause the subcontractor to obtain, such increased, extended, or special insurance. Any additional costs therefor shall be allowed as extras by IWMC upon submission of evidence of such increases.

8.3 Non-Recourse Provision

Where permitted, the Required Insurance policies shall provide that the insurers shall have no recourse against any additional insureds thereunder for payment of any premium assessment and shall each contain a severability of interest provision and a cross liability clause.

8.4 Workers' Compensation Coverage

- (a) The Contractor shall, throughout the Term and any Extension Term (s), pay all premiums and assessments for workers' compensation insurance as required by Applicable Laws with respect to

all employees of the Contractor engaged in the Work.

- (b) In addition to the letter of good standing provided with the Technical Proposal, the Contractor shall also provide a copy of its letter of good standing from the Prince Edward Island Worker's Compensation Board, or equivalent entity in other jurisdictions, just prior to the Effective Date.

9. Force Majeure

9.1 Force Majeure Event

- (a) Any of the following events (each a "**Force Majeure Event**") which, either separately or together, materially affect the ability of the Contractor or IWMC to perform their respective obligations as set forth in this Agreement or Schedule B – Work Specification:

- (i) strike or lockout which is directed at the Work, or the Contractor or IWMC;
- (ii) acts of a public enemy, including war and public riots;
- (iii) lightning, fire, hurricane or flood or any other extreme weather event;
- (iv) radioactive, chemical or biological contamination;
- (v) pressure waves caused by devices travelling at supersonic speeds; or,
- (vi) epidemics or pandemics,

provided that any such Force Majeure Event does not result from any action or failure to act by the Contractor or IWMC, as the case may be, and any other cause, whether of the kind specifically enumerated above or otherwise.

- (b) Subject to Section 9.1(c), if, due to a Force Majeure Event, either the Contractor or IWMC is rendered unable to materially carry out any of its respective obligations as set forth in this Agreement or Schedule B – Work Specification, those respective obligations, only so far as they are affected by such Force Majeure Event, shall be suspended or delayed during, but no longer than, the continuance of such Force Majeure Event and any time for performance of such obligations shall be extended for a period equal to the period of such Force Majeure Event. For clarity, regardless of the delay caused by a Force Majeure Event, the period between the Operations Effective Date and the Expiry Date shall not exceed 5 years.
- (c) Where the Contractor or IWMC wish to rely upon the provisions of this Section 9 with respect to a delay caused by a Force Majeure Event, the Contractor or IWMC, as the case may be, shall, within 3 days of the Force Majeure Event, give immediate written notice to the other Party, which notice

shall describe the Force Majeure Event, its cause, the probable duration of the delay resulting therefrom, and the steps being taken by the Party to mitigate the impact of the Force Majeure Event on the performance of the Party's obligations.

- (d) The Contractor or IWMC, as the case may be, which is rendered unable to carry out its obligations due to the Force Majeure Event shall use all reasonable diligence to remedy such delay as quickly as possible, provided that such requirement shall not require the settlement of strikes, lockouts or other labour difficulties by such Party contrary to its wishes.
- (e) Neither the Contractor nor IWMC shall be permitted to claim against, or from, the other for any increase in Prices, or additional costs and expenses a Party incurs, that may result from the delay or suspension of a Party's obligations due to a Force Majeure Event.
- (f) Notwithstanding the foregoing provisions of this Section 9, if a delay or suspension of a Party's obligations arising from a Force Majeure Event continues for a duration of more than 14 consecutive days, IWMC may, in its sole discretion, terminate this Agreement upon 3 days prior written notice to the Contractor. In the case of termination by IWMC pursuant to this Section 9(f), the Contractor shall be entitled to receive payment only for the Work provided prior to the termination date which has met the requirements of this Agreement and Schedule B – Work Specification, and such payment shall constitute full and final satisfaction of IWMC's obligations to the Contractor with respect to this Agreement.
- (g) In the event of any disagreement between IWMC and the Contractor as to the extent of a delay or suspension that is caused by the Force Majeure Event, the dispute shall be resolved pursuant to the Dispute Resolution Procedure (Section 18 of this Agreement).

10. SUSPENSION OF WORK

10.1 IWMC's Right to Suspend Work

IWMC may, at any time, suspend the Work, or any part thereof, by giving two (2) days prior written notice to the Contractor. The Contractor shall not be entitled, by reason of IWMC's suspension order, to any additional payment, loss of profit or anticipated profit, or damages of any kind. Unless IWMC's suspension of the Work was due to the Contractor's negligence or non-performance of its obligations as set forth in this Agreement and Schedule B – Work Specification and as determined by IWMC under this Agreement, IWMC shall continue to pay the Contractor during the period of suspension as if the Contractor was still performing its obligations.

11. TERMINATION

11.1 Termination for Convenience by IWMC

- (a) IWMC may, at its sole discretion, terminate this Agreement without cause at any time prior to the expiration of the Term, or Extension Term(s) as the case may be, upon giving 120 days prior written notice of termination to the Contractor.
- (b) In the case of a termination in accordance with Section 11.1(a), the Contractor shall be entitled to receive payment for the Work it has satisfactorily performed up to the date of the termination, and where applicable, to the payment of any holdback which IWMC is then holding at such time.
- (c) In the case of a termination in accordance with Section 11.1(a), the Contractor shall not be reimbursed for any profits that may have been anticipated but not earned up to the termination date, and the Contractor shall not have any claim or entitlement to any additional compensation or damages arising from such termination.
- (d) Payments to the Contractor of the foregoing amounts shall constitute full and final satisfaction of IWMC's obligations to the Contractor under this Agreement for a termination in accordance with this Section 11.1.

11.2 Event of Default

Each of the following shall constitute an Event of Default on the part of the Contractor:

- (a) a breach by the Contractor of any of the terms, conditions, covenants, warranties, representations, provisions or requirements of this Agreement or any failure or refusal of the Contractor to perform, meet or comply with any of its obligations hereunder;
- (b) a statement, representation or warranty made by the Contractor in the Contractor's Proposal, or this Agreement, is untrue or incorrect;
- (c) a failure by the Contractor to comply with any Applicable Law, including any licence, permit or policy, in connection with the performance of the Work except to the extent, if any, such failure is excused due to a Force Majeure Event in accordance with this Agreement;
- (d) a failure by the Contractor to obtain and maintain the Required Insurance or the Performance Security in accordance with this Agreement;
- (e) if the Contractor fails to rectify Service Failures, as set forth in Section 14.1(c)(ii);
- (f) if the Contractor converts or retains any Source-Separated Solid Waste or Organics for its own

purposes or does not perform the Collection and Transportation in the manner required by this Agreement;

- (g) any other event of default as expressly set forth in this Agreement;
- (h) if the Contractor consistently disregards the instructions of IWMC's Solid Waste Collection Representative or the Disposal Manager if such instructions are issued reasonably in accordance with this Agreement; or,
- (i) if the Contractor admits in writing that it is insolvent or bankrupt; or if the Contractor files a voluntary petition in bankruptcy under Canadian or United States bankruptcy laws; or if the Contractor consents to the appointment by a court of a receiver or trustee for all or a substantial portion of its property or business; or the Contractor makes any arrangement with or for the benefit of its creditors involving an assignment to a trustee, receiver or similar fiduciary, regardless of how designated, of all or a substantial portion of its property or business or the Contractor is adjudicated by a court of competent jurisdiction to be bankrupt after the filing of a petition against it under Canadian or United States bankruptcy laws.

11.3 Responsibilities of the Contractor on Event of Default

If an Event of Default on the part of the Contractor occurs after the Effective Date then, at its own cost and expense, the Contractor shall:

- (a) work diligently using commercially reasonable efforts to cure the Event of Default by the earliest date possible; and,
- (b) take all commercially reasonable actions necessary to eliminate the cause of the Event of Default and prevent recurrences including, without limitation, making repairs, replacements, and changes to operating procedures.

11.4 Costs and Expenses on Event of Default

Unless it is agreed by the Contractor and IWMC in writing or determined pursuant to the Dispute Resolution Procedure that an Event of Default on the part of the Contractor has not occurred, all costs and expenses incurred by the Contractor to perform or comply with its obligations under Section 11.3 shall be for the Contractor's own account and the Contractor shall not be entitled to any adjustment in the Prices on account of such costs and expenses, unless otherwise provided in this Agreement.

11.5 IWMC's Termination Rights

- (a) IWMC shall have the right, at its option, to terminate this Agreement, in addition to and without limitation or prejudice to any other rights or remedies to which IWMC may be entitled at law, in

equity or under any other provisions of this Agreement (including the calling of all or a portion of the Performance Security the Contractor is to provide in accordance with this Agreement) if the Contractor fails to cure any Event of Default on the part of the Contractor, not caused by an act or omission of IWMC, within 30 days after notice thereof from IWMC (or if the nature of the Event of Default is such that it cannot be cured within 30 days, then, if the Contractor is using its diligent best efforts to cure the default, within 60 days after notice from IWMC) unless such Event of Default:

- (i) is trivial and of a minor nature, as solely, but reasonably, determined by IWMC; or
 - (ii) does not preclude, prevent, or materially interfere with or affect the Work or the Collection and Transportation and does not increase any costs or expenses to IWMC.
- (b) The notice provided by IWMC in accordance with Section 11.5(a) shall set out:
- (i) the nature of the default; and
 - (ii) the general way in which IWMC requires the default to be corrected.

11.6 Remedies Cumulative

The rights and remedies of IWMC set out in this Agreement are non-exclusive, cumulative and are in addition to, and not in substitution for, any other rights or remedies available to IWMC at law or in equity. IWMC shall have the right to pursue any of its remedies in conjunction with all other available legal remedies and damages should the Contractor be in breach of any of its duties and obligations under the Agreement.

11.7 Costs of Suspension or Termination

- (a) If this Agreement is suspended by IWMC pursuant to Section 10.1, due to the Contractor's negligence or non-performance of its obligations as set forth in this Agreement, or terminated for cause pursuant to Section 11.5, the Contractor shall be responsible for and shall reimburse IWMC for all losses, costs and damages incurred by IWMC as a result of, or arising from, the suspension or Event of Default as applicable, including any costs incurred by IWMC to correct any defects or deficiencies in any of the Work, and any costs incurred by IWMC to procure the Work or any part thereof from another provider.
- (b) IWMC has the right and may decide, in its sole discretion, rather than to be reimbursed directly by the Contractor as set forth in Section 11.7(a), to call all, or a portion of, the Performance Security, in order to satisfy all IWMC's costs and expenses as set forth in Section 11.7(a).

11.8 Survival of Certain Terms and Conditions

Neither the expiration of the Term, or an Extension Term(s), nor the earlier suspension or termination of this Agreement shall relieve, or be deemed to relieve, the Contractor from any duties, obligations or liabilities hereunder that accrued prior to such expiration or termination, or which by their nature are intended to survive the expiration or earlier termination of this Agreement, including, but not limited to, all warranties given by the Contractor in respect of the Work, including, but not limited to those set forth in Section 3, and those duties and obligations of the Contractor set out in Section 4 (Contractor's Obligations), Sections 5.4 and 5.5, Section 6 (Material Rights), Section 7 (Invoicing and Payments), Section 8 (Insurance) Section 9, Section 11 (Termination), Section 12 (Indemnification), Section 16 (Confidentiality) and Section 17 (Status of the Parties).

11.9 Event of Default by IWMC

For the purposes of this Agreement, an Event of Default on the part of IWMC shall occur when IWMC has failed to pay an amount due and owing to the Contractor under this Agreement on the due date as set forth in this Agreement (which amount is not being disputed in good faith) and has not remedied such failure within 14 days of receiving a written notice from the Contractor.

11.10 The Contractor's Option on IWMC's Event of Default

If, after the 14 day period set forth in Section 11.9 has expired, IWMC has not remedied the failure, as required by Section 11.9, the Contractor may issue IWMC written notice of its intention to terminate this Agreement no earlier than 5 days after IWMC's receipt of such written notice. If IWMC has not remedied the failure within this 5 day period, the Contractor may then terminate this Agreement.

11.11 Transitional Arrangements

(a) The Contractor will:

- (i) on request by IWMC, for a period not to exceed 3 months after the date of a termination as set forth in this Section 11:
 - (1) co-operate fully with IWMC and any successor providing services to IWMC to achieve a smooth transfer of services and to avoid or mitigate risk to the health and safety of users of any facilities or equipment; and,
 - (2) continue to provide the Work or any part of the Work required by IWMC and IWMC will pay to the Contractor a proportionate price for such Work determined with reference to the Contractor's price for such Work prior to the date of the termination; and,

- (ii) subject to Section 11.11(a)(i), as soon as practicable following the date of the termination, remove from the real property of IWMC, all of the Contractor's property, including equipment and materials, of the Contractor that IWMC has not agreed to purchase from the Contractor (or not belonging to IWMC) and if it has not done so within 30 days after any notice from IWMC requiring it to do so, IWMC may (without being responsible for any loss, damage, costs or expenses) remove and sell any such property and will hold any proceeds less all costs incurred to the credit and direction of the Contractor;

11.12 Continued Performance

Subject to the provisions of this Section 11, the Parties will continue to perform their obligations under this Agreement (including IWMC continuing to pay the Prices) notwithstanding the giving of any notice of default or notice of termination.

12. **Indemnification**

- (a) It is the express intention of the Parties that, except as expressly provided for herein, IWMC shall not be liable to the Contractor by reason of entering into, or in connection with any part of this Agreement, for any lost profits, indirect damages or consequential losses regardless if such lost profits, indirect damages or consequential losses result from this agreement or another agreement or opportunity of the Contractor.
- (b) The Contractor agrees that it will protect, indemnify and hold harmless IWMC and its board of directors, representatives, officers, employees, agents and contractors (the "**Indemnified Parties**") from and against (and pay the full amount of) all liabilities, actions, damages, claims, demands, judgments, fines, losses, costs, expenses, penalties, suits or actions and all legal fees and costs (collectively, "**Losses and Expenses**"), and will defend IWMC and the Indemnified Parties in any suit, including appeals, for personal injury to, or death of, any person, or loss or damage to property (including, without limitation, damage to any property adjoining or adjacent to a Serviced Unit or designated Receiving Facility) arising out of or resulting from:
 - (i) any performance or non-performance, negligent or otherwise, by the Contractor or its subcontractors of their respective obligations as set forth in this Agreement; or,
 - (ii) a breach or violation of Applicable Law by the Contractor or its subcontractors.
- (c) The Contractor shall not, however, be required to reimburse or indemnify any Indemnified Party for any Losses and Expenses to the extent due to the negligent or wrongful conduct of any Indemnified Party.
- (d) IWMC shall promptly notify the Contractor of the assertion of any claim against it or an Indemnified Party for which it is entitled to be indemnified hereunder, shall give the Contractor

the opportunity to defend such claim, and shall not settle the claim without the approval of the Contractor.

- (e) The indemnification provisions set forth in this Section 12 are for the protection of IWMC and the Indemnified Parties only and shall not establish, of themselves, any liability to third Parties. The provisions of this subsection shall survive the expiration of or earlier termination of this Agreement.

13. Protection of the Public and of Works and Property

The Contractor shall take all reasonable precautions to protect IWMC's property and Receiving Facilities from injury or loss arising in connection with the Contractor's performance of the Work. Any damage to IWMC's property or Receiving Facilities caused by the Contractor or its subcontractors shall be the responsibility of the Contractor and the costs of any repairs may be deducted by IWMC from monies due to the Contractor.

14. Service Failures and Deductions

14.1 Service Failures

- (a) Upon the first occurrence of a Service Failure (a "**Service Failures**"), IWMC and the Contractor shall, both parties acting reasonably, discuss the events leading to the Service Failure and the mitigation measures to be employed by the Contractor to avoid the Service Failure from reoccurring.
- (b) If the same Service Failure occurs a second time, and for each subsequent Service Failure, IWMC shall be entitled to the corresponding Deduction as set forth in the table at Section 14.3. The Contractor acknowledges and agrees that it is the intention of IWMC to apply Deductions in a reasonable manner throughout the Operational and Extension Term(s) and that the use of Deductions by IWMC is to encourage the Contractor to prevent and/or correct any performance of the Work that leads to Service Failures.
- (c) In addition to, and not in substitution for, IWMC's entitlement to Deductions as set forth in Section 14.1(a), if the Contractor is unable, or unwilling, to correct Service Failures or Special Service Failures after multiple occurrences of the same Service Failure or Special Service Failure, as applicable, and after requests from IWMC to address and correct such Service Failure or Special Service Failure, IWMC may, in its sole discretion, choose to
 - (i) suspend the Work in accordance with Section 10.1. Such suspension shall be due to the Contractor's negligence or non-performance of its obligations, as set forth in this Agreement and Schedule B – Work Specification, and the Contractor shall not be entitled to payment of the Prices during such suspension; or,

(ii) terminate this Agreement in accordance with Section 11 for a Contractor Event of Default.

14.2 Procedure for Deductions

Following the end of each month of the Operational Term or an Extension Term(s), IWMC shall determine the aggregate amount of Deductions arising from Service Failures for that month. That aggregate amount of Deductions shall then be deducted from the total amount that IWMC was to pay the Contractor for that month, as such total amount is set forth in the invoice provided to IWMC in accordance with Section 7.2.

The number of Service Failures set forth in the table in Section 14.3, shall aggregate over the Operational Term, and Extension Term(s) if applicable, and not aggregate on a per month basis.

Should the Contractor dispute the deductions relating to the Service Failures or the Special Service Failures for the month, the dispute shall be addressed in accordance with the dispute resolution procedure as set forth in Section 18.

14.3 Service Failures and Deduction Amounts

Following are Service Failures and the corresponding Deductions that shall apply to this Agreement in accordance with Section 14.

Description of Service Failure by the Contractor	Reference	Deduction Amount
Failure to complete its collection routes on the scheduled day, as per IWMC’s Collection Schedule.	Agreement – Section 4.15(a) and Section 4.15(b)	\$500.00 per occurrence; after 5 days \$1,000.00 per occurrence
Failure to complete the collection of Spring and Fall Cleanup or Christmas tree collection by the end of the scheduled week	Schedule B – Work Specification – Section 5.8 (g) and Section 5.9(a)	Holdback of 100% of the price until complete and a penalty of \$1,000.00 per day until completed.
Failure of personnel to wear personal protective equipment as required.	Schedule B – Work Specification – Section 4.2	\$100.00 per reported incidence.
Failure to complete all of the required stops on its collection routes on a working day (i.e., the Contractor has not collected all the carts and allowed excess material) and if not remedied	Schedule B – Work Specification – Section 11.2(b)	\$100.00 per cart or excess material.

Description of Service Failure by the Contractor	Reference	Deduction Amount
by the end of the two days after notification.		
Failure to keep Christmas trees separate from cart organics	Schedule B – Work Specification – Section 5.9(b)	\$1,000 per load
Failure to tag/sticker and reject Waste, Organics, Spring and Fall Cleanup materials or Christmas trees that do not conform to the requirements of Waste, Organics, Spring and Fall Cleanup materials and Christmas trees that are permitted to be collected.	Schedule B – Work Specification – Section 5.13 and 5.14	\$100.00 per incident.
Failure to collect the correct amount of Waste or Organics from Serviced Units (i.e., the Contractor collects materials from less than or more than the permitted number of containers).	Schedule B – Work Specification – Section 5.5(a) and 5.5(b)	\$100.00 per incident.
Failure to submit a Daily Driver’s Report and /or failure to include the required information on the Daily Drivers Report.	Schedule B – Work Specification – Section 12.1	\$100.00 per incident
Failure to have its equipment, including its Contractor collection vehicles, designed to meet the applicable requirements.	Schedule B – Work Specification – Section 3.5	Holdback of 10% of the payment on each monthly invoice until remedied.
Failure to maintain its equipment, including its Contractor collection vehicles, in accordance with the applicable requirements.	Schedule B – Work Specification – Section 3.6	Holdback of 10% of the payment on each monthly invoice until remedied.
Failure to respond to IWMC’s Customer Service Centre regarding a Resident’s complaint/concern after 3	Schedule B – Work Specification – Section 11.1	\$100.00 per incident if no response by end of the third day after the day the

Description of Service Failure by the Contractor	Reference	Deduction Amount
days.		request was made.
Failure to return waste or organics Carts, including excess material Containers to identified holding area (e.g., at multi-unit residences).	Schedule B – Work Specification – Section 7.1 (a)	\$100.00 per occurrence.
Rude, abusive or disrespectful behavior displayed by Contractor’s staff to residents/customers or IWMC staff.	Agreement – Section 4.1(a), Schedule B – Work Specification – Section 2.1(a)(ii), and Section 11.1(a)(i)(1)	\$100.00 per documented occurrence

14.4 Special Service Failures and Deduction Amounts

- (a) The following three types of incidents shall each be considered to be a Special Service Failures, and, subject to Section 14.1(c) and 14.2:
- (i) the mixing, comingling or inclusion of ICI Organic materials or ICI Waste materials not collected under this Agreement in a Collection Vehicle of the Contractor with the Residential Organics and Waste Materials that have been collected in accordance with this Agreement. Collection vehicles employed by the Contractor to carry out the Work shall only discharge either Organics or Waste materials at an IWMC final disposal facility that have been collected under this Agreement, and no other materials of any kind. Upon the first and second instance of such mixing, incorporating, comingling or sorting during the Operational and Extension Term(s) of this Agreement, the corresponding Deduction shall be \$10,000. The third instance of such mixing, incorporating, comingling or sorting may be considered by IWMC, in its sole discretion, to be an event of default in accordance with Section 11.2(g) and IWMC may choose to terminate this Agreement in accordance with Section 11 or to continue to levy a Deduction of \$10,000 per instance of this Special Service Failure;
 - (ii) in accordance with Section 3.1 of Schedule B – Work Specification, regarding the age of vehicles to be used by the Contractor in the performance of the Work, for each month or portion thereof that the age of a Contractor’s collection vehicle does not meet the minimum requirement, the corresponding Deduction shall be \$2,000 per vehicle; and,
 - (iii) in accordance with Section 3.5(f) of Schedule B – Work Specification, regarding the Contractor’s oversight and management of property of IWMC or the public, the associated

Deduction per month shall equal the aggregate of all actual costs incurred by IWMC resulting from damage, caused by the Contractor, to Organics or Waste receptacles or containers, including, but not limited to, Carts.

15. Change Order Process

- (a) Should the Contractor wish to make a material change to any aspect of the Agreement, the Contractor shall initiate the Change Order process and shall submit a draft Change Order to IWMC which must include supporting documentation necessary for IWMC to evaluate the Contractor's draft Change Order. Within 21 days of receipt IWMC shall review the draft Change Order and may request further information from the Contractor in order to support the draft Change Order. If IWMC does not accept the Contractor's draft Change Order, IWMC shall notify the Contractor and provide reasons, in reasonable detail, for the rejection of, or required amendments to, the draft Change Order. If IWMC agrees with the draft Change Order, IWMC and the Contractor will negotiate an equitable adjustment to the Work and, if required, the Prices. A written agreement by both IWMC and the Contractor to a Change Order shall be in the form of a change certificate (the "**Change Certificate**"). No change to the Work under this Agreement shall occur without a Change Certificate executed by IWMC and the Contractor. The Contractor may not suspend, in whole or in part, performance of the Work during any dispute over any Change Order request.
- (b) IWMC may submit a draft Change Order to the Contractor in writing. Within 21 days of receipt the Contractor shall review the draft Change Order and advise IWMC of its response to the requested change and shall submit a change proposal to IWMC stating:
 - (i) the increase or decrease, if any, in the Prices which would result from such change; and,
 - (ii) the effect, if any, upon the Contractor's performance of the Work by reason of such proposed change. The Contractor's change proposal must include supporting documentation reasonably requested by or necessary for IWMC to evaluate the Contractor's change proposal. IWMC shall have 21 days to accept or reject in writing the Contractor's change proposal in relation to the requested Change Order. If IWMC accepts the Contractor's change proposal, IWMC and the Contractor shall execute a Change Order reflecting the requested change in the Work and the agreed upon adjustments, if any, to the Prices. In the event IWMC disagrees with the Contractor's draft Change Order, then IWMC shall notify the Contractor, within the 21-day period, that IWMC has decided to withdraw its draft Change Order. No change to the Work under this Contract shall occur without a Change Certificate executed by IWMC and the Contractor.
- (c) If IWMC and the Contractor cannot agree on the pricing for the Change Order set forth in Section 15(b), the matter shall be resolved in accordance with the Dispute Resolution Procedure outlined in Section 18 hereof.

- (d) The Contractor may not suspend, in whole or in part, performance of the Work during any dispute over any Change Order request or IWMC's direction to proceed or on account of any dispute regarding amounts claimed to be owed to the Contractor under this Agreement, unless directed to do so by IWMC. If directed by IWMC to proceed with the IWMC's draft Change Order, pending review and agreement upon such Change Order adjustments or resolution of such dispute, the Contractor shall (without waiving any rights or remedies with respect to such Change Order or dispute) do so.

16. Confidentiality

- (a) The Contractor acknowledges and confirms that all information provided to it by IWMC hereunder, or to which the Contractor has access as a result of providing the Work to IWMC is confidential information ("**Confidential Information**"). Unless required by Applicable Law or an order of a court of competent jurisdiction, such Confidential Information shall not, either during the Term, an Extension Term(s), or at any time thereafter, be disclosed by the Contractor, without the prior written consent of IWMC, to any third Party or to any employees of the Contractor, other than its employees who are directly involved in providing the Work.
- (b) The Contractor shall implement and maintain security standards and procedures for the safeguarding of IWMC's Confidential Information to prevent unauthorized access thereto and to ensure compliance with Applicable Law. The Contractor agrees to promptly notify IWMC in writing upon becoming aware of a breach of either the Contractor's security standards and procedures or IWMC's security policies, or any unauthorized disclosure of information that the Contractor is required to keep confidential in accordance with this Agreement or Applicable Law. The Contractor shall take immediate steps to mitigate any breach or unauthorized disclosure described in this Section 16.
- (c) The Contractor acknowledges and agrees that IWMC may disclose this Agreement or portions thereof as may be required pursuant to the *Freedom of Information and Protection of Privacy Act R.S.P.E.I. 1988, Cap. F-15.01*.
- (d) If the Contractor is a "service provider" as defined in the Personal Information International Disclosure Act ("**PIIDPA**") as a result of the type of Work that it is providing to IWMC under this Agreement, the Contractor represents, warrants and undertakes to IWMC that it shall comply with its obligations under PIIDPA and the terms and conditions contained in the Privacy Protection Schedule, attached as Schedule E to this Agreement.

17. Status of the Parties

This Agreement is a contract for the performance of the Work. The Contractor is engaged by IWMC hereunder as an independent contractor and shall not at any time hold itself out as an employee, servant or agent of IWMC. The Contractor shall not have authority under this Agreement to bind IWMC,

or to commit IWMC to the payment of money to any third Party.

No employment relationship is created between the Contractor, or any of its employees, and IWMC. The Contractor shall be responsible for all payroll functions and shall pay in a timely manner all salaries and benefits, taxes, employment insurance premiums, Canada Pension Plan premiums or contributions, Workers Compensation Act assessments and any other assessments or contributions of any kind or nature whatsoever that are payable to any governmental authority in respect of the Contractor's employees.

This Agreement does not create, and shall not be construed as creating, a partnership, joint venture, or agency relationship between the Parties. To the extent that the term "partner" or "partnership" may be utilized in this Agreement or in describing the relationship between the Parties, such terms shall be utilized merely to convey the anticipated spirit of cooperation between the Parties and is in no way intended to establish joint and several liability, fiduciary duties, or other implications of the legal term of "partner."

18. Dispute Resolution Procedure

18.1 Settlement of Disputes

The Dispute Resolution Procedure described in this Section 18 shall apply to any and all disputes between IWMC and the Contractor, which may arise out of or in connection with this Agreement, unless specifically precluded. Any Party desiring redress, remedy, or relief of any kind against the other Party in relation to any such dispute shall pursue the same in accordance with the procedure set out in this Section 18 which shall be the sole means of resolving disputes under the Agreement. Notwithstanding any other provision of this Agreement, either Party may bring an action or application at law or in equity within the jurisdiction of the Province of Prince Edward Island in respect to any of the following:

- (a) an injunction;
- (b) specific performance; or
- (c) enforcement of an indemnity.

18.2 Notice of Dispute

Delivery upon one Party of a written notice from the other Party that details the nature of the dispute shall constitute proper notice of the dispute (the "**Notice of Dispute**").

18.3 Multi-Step Dispute Procedure

If a dispute arises between the Parties relating to this Agreement, the Parties agree to use the following procedure:

- (a) The Parties agree that upon delivery of the Notice of Dispute, the Parties' respective senior management teams shall engage in a process of good faith negotiation in an effort to resolve the dispute;
- (b) If within 30 days following the delivery of a Notice of Dispute, the Parties senior management teams have not succeeded in negotiating a resolution of the dispute, the Parties agree to refer the dispute to arbitration to settle the dispute in accordance with the *Arbitration Act* R.S.P.E.I. c. A-16 and the decision of the arbitrator shall be final and binding; and,
- (c) The Parties agree that the arbitration will be by a single arbitrator if the Parties can agree on the appointment and, if the Parties do not agree on such appointment within 10 days of the exchange of correspondence in respect of the nomination of a single arbitrator, then either of the Parties may make application to a court of competent jurisdiction to have a single arbitrator appointed pursuant to the provisions of the *Arbitration Act* R.S.P.E.I. c. A-16.

18.4 Pre-Agreement on Arbitrator

Notwithstanding anything contained in Section 18.3, the Parties may at any time mutually agree, in advance, upon those persons who shall constitute the arbitrator to deal with any future disputes which may arise hereunder.

18.5 Costs of Arbitration

The fees of the arbitrator shall be shared by the Parties equally.

18.6 Party's Cost of Arbitration

Each of the Parties shall bear its own costs other than the fees of Arbitration in connection with such proceedings and the arbitrator shall have no power to award costs to either Party.

18.7 Effect of Dispute Resolution Process

Notwithstanding the foregoing, nothing in this Section 18 shall prevent IWMC from exercising its rights of termination set out in Section 11.5, in the circumstances described for such termination.

19. Notices

- (a) Any notice to be given under this Agreement by IWMC or the Contractor shall be in writing and delivered by hand, by email transmission or by registered mail, to the other Party at the address and to the attention of the contact individual indicated below:

To IWMC:
c/o Karen MacDonald
Chief Executive Officer
110 Watts Avenue
Charlottetown, PE C1E 2C1
kmacdonald@iwmc.pe.ca

To the Contractor:
c/o Solid Waste Collection Representative
[Insert Contractor's mailing address]
[Insert Contractor's email address]

- (b) A notice shall be deemed to be duly given and received upon delivery, if delivered by hand; upon receipt of the email transmission, if the transmission is confirmed received by the intended recipient or by the sender via a "read receipt" prior to the recipient's close of business (and otherwise on the next business day of the recipient); or 7 days after posting, if sent by registered mail with a return receipt.
- (c) Either Party may change its address or contact for receipt of notices, provided that such Party gives notice thereof in accordance with this Section 19 and confirms the effective date of the change in such notice.

20 General Terms

20.1 Enurement

This Agreement shall enure to the benefit of, and be binding upon, the Parties hereto and their respective heirs, executors, administrators, successors and permitted assigns.

20.2 Assignment

- (a) The Contractor shall not assign this Agreement or any part thereof without the prior written consent of IWMC which consent may be withheld by IWMC in its sole discretion. Any purported assignment or subcontracting by the Contractor without such consent shall be of no force or effect. A change in the control of the Contractor shall be deemed to be an assignment for the purposes of this Section 20.2.

- (b) IWMC's consent to an assignment of this Agreement, or the subcontracting of the performance of any of the Work to be provided by the Contractor hereunder, shall not relieve the Contractor from any of its obligations under this Agreement and the Contractor shall, notwithstanding any such consent by IWMC, remain responsible for the performance of the Work and all other obligations of the Contractor set out herein.
- (c) IWMC may, at its discretion, assign this Agreement without prior notice to the Contractor.

20.3 Waiver

No action of IWMC pursuant to this Agreement (including, but not limited to, any investigation or payment), and no failure to act, shall constitute a waiver by IWMC of the Contractor's compliance with any term or provision of this Agreement. No course of dealing or delay by IWMC in exercising any right, power or remedy under this Agreement shall operate as a waiver or otherwise prejudice IWMC's rights, powers and remedies as set forth in this Agreement. No single or partial exercise of (or failure to exercise) any right, power or remedy of IWMC under this Agreement shall preclude any other or further exercise thereof or the exercise of any other right, power or remedy.

20.4 Time of Essence

Time is of the essence of this Agreement.

20.5 Headings

The headings appearing in this Agreement have been inserted as a matter of convenience and for reference only and in no way define, limit, or enlarge the scope or meaning of this Agreement or any of its provisions.

20.6 Number and Gender

This Agreement shall be read with all changes in number and/or gender as the context may require.

20.7 Terms Severable

The terms and provisions of this Agreement shall be severable and should any term or provision be found by a court of competent jurisdiction to be legally unenforceable, inoperative or invalid, the remainder of this Agreement shall continue in full force and effect to bind the Parties and it is hereby declared that it is the intention of the Parties that they would have executed the remaining portion of this Agreement without including any such part, parts or portion which may, for any reason, be hereafter declared unenforceable, inoperative or invalid.

20.8 Law of Agreement

This Agreement shall be governed by the laws of the Province of Prince Edward Island and the laws of Canada applicable therein and the Parties do hereby irrevocably submit and attorn to the jurisdiction of the Courts of the Province of Prince Edward Island in respect of all matters arising out of or relating to this Agreement or the transactions contemplated hereby.

20.9 Further Assurances

The Parties will do, execute and deliver, or will cause to be done, executed and delivered, all such further acts, documents (including certificates, declarations, affidavits, reports and opinions) and things as the other may reasonably request for the purpose of giving effect to this Agreement or for the purpose of establishing compliance with the representations, warranties and obligations of this Agreement.

20.10 Electronic Signatures

This Agreement may be signed electronically and in counterparts. The Parties agree that signatures transmitted and received via electronic transmission shall be treated for all purposes of this Agreement as original signatures and shall be deemed valid, binding, and enforceable by and against all Parties.

[Remainder of page intentionally blank - Next page is the signature page]

The Parties have executed this Agreement through their authorized representatives on the day and year first above written.

Island Waste Management Corporation

Per: _____

Name:

Title:

[Insert Legal Name of Contractor]

Per: _____

Name:

Title:

SCHEDULE C

1. THE MONTHLY PAYMENT AMOUNT

- (a) The monthly payment amount to be invoiced by the Contractor and paid by IWMC shall be based on the Monthly Payment Table for the applicable contract year, pursuant to the Cost Proposal submitted by the Contractor. The annual price per unit for each collection type shall be converted to a Monthly Price per unit by dividing it by twelve (12). The applicable number of units to be used for the Monthly invoicing calculation will be adjusted each year, as set out in the Agreement and as described in 1(b) which follows. The Monthly Payment Table shall show the Monthly Payment Amount for each month of the contract year.
- (b) The Monthly Payment Table will be prepared by IWMC and provided annually to the Contractor. In the event it is not provided in time for the first monthly invoices of the next contract year, the Contractor shall continue to invoice IWMC based on the number of serviced units and Monthly unit prices in the previous month's invoice. Upon receipt of the updated Monthly Payment Table for the current year, the Contractor shall prepare an adjustment invoice to reflect the required changes to any amounts already invoiced. IWMC shall pay any amount owing by it to the Contractor from the adjustment invoice or shall apply any credit due to it as an offset against the Monthly Payment Amount owing to the next monthly invoice from the Contractor.
- (c) In the event the Contractor disagrees with the information provided by IWMC in the Monthly Payment Table, it shall have 14 days to so indicate, following which the Dispute Resolution mechanism as set out in Section 18 of the Agreement.

2. ANNUAL RECONCILIATION OF THE MONTHLY PAYMENT AMOUNTS

- (a) In accordance with the Agreement under Section 7.2(j), annually following the end of each contract year IWMC shall prepare a reconciliation of the amounts paid to the Contractor for the twelve months of the contract year to an Adjusted Annual Payment Amount based on the annual price per unit submitted by the Contractor as part of the Cost Proposal and accepted by IWMC, multiplied by an adjusted number of serviced units. The adjusted number of serviced units shall comprise the number of serviced units for the prior year plus 50% of the increase or decrease from the previous number.
- (b) The adjusted number of service units shall be based on the most recent information available and provided to IWMC by the Property Taxation Department of the PEI Government for the contract year just completed.

3. MONTHLY PAYMENT AMOUNTS FOR EXTENSION TERM(S)

For each year of an Extension Term(s), the applicable annual price per unit to be used in the preparation

of the Monthly Payment Table, which IWMC shall pay to the Contractor and which the Contractor agrees to accept for its performance of the work for the year, shall be the price per unit for the immediately preceding year increased by 75% of the Consumer Price Index (all items) (to the nearest one hundredth), for Canada as published by Statistics Canada, for the 12-month period immediately preceding the commencement of the Extension Term(s).

Table A4: Monthly Payment Calculation and Table

MONTHLY PAYMENT CALCULATION - Eastern Kings Region							Page 1
(See Cost Proposal Submission Form)							
Contractor: <u>Clean Crazy Waste Inc.</u>		Collection Year From Nov 1, 2024		TO	'Oct 31, 2025		
COLLECTION TYPE	SERVICE MODE	# ANNUAL COLLECTIONS	# OF UNITS *	PRICE PER UNIT	MONTHLY PAYMENT	FORMULA	
		A	B	C			
1	Year Round Biweekly carts,						
Waste	Weekly	26	4,158	1.50	\$ 13,513.50	(AxBxC)/12	
Organics	Weekly	26	4,158	1.60	\$ 14,414.40	(AxBxC)/12	
2	Seasonal Biweekly carts,						
waste and organics	Weekly	18	1212	2.00	\$ 10,908.00	(AxBxC)/4	
3	Extended Seasonal Biweekly						
carts, waste and organics	Weekly	24	170	2.00	\$ 1,360.00	(AxBxC)/6	
4	Spring / Fall Cleanup - Separate Organics Collection						
2 weeks each season	As scheduled	4	4,158	1.10	\$ 9,147.60	(AxBxC)/2	
5	Christmas Tree Collection						
	once	1	4,158	0.35	\$ 1,455.30	(AxBxC)/1	
(See page 2 for the Monthly Payment Table - Amounts for Each month depending on the service performed)							

MONTHLY PAYMENT TABLE - Eastern Kings Region *

SAMPLE ONLY

Page 2

Contractor: <u>Clean Crazy Waste Inc.</u>		Collection Year From										TO 'Oct 31, 2025				
		Nov	Dec	Jan	Feb	Mar	Apr	May	Jun	Jul	Aug	Sep	Oct			
		\$	\$	\$	\$	\$	\$	\$	\$	\$	\$	\$	\$			
1	Year Round Biweekly carts,															
	Waste	\$ 13,513.50	\$ 13,513.50	\$ 13,513.50	\$ 13,513.50	\$ 13,513.50	\$ 13,513.50	\$ 13,513.50	\$ 13,513.50	\$ 13,513.50	\$ 13,513.50	\$ 13,513.50	\$ 13,513.50			
	Organics	14,414.40	14,414.40	14,414.40	14,414.40	14,414.40	14,414.40	14,414.40	14,414.40	14,414.40	14,414.40	14,414.40	14,414.40			
2	Seasonal Biweekly carts,								10,908.00	10,908.00	10,908.00	10,908.00				
	waste and organics															
3	Extended Seasonal Biweekly															
	carts, waste and organics							1,360.00	1,360.00	1,360.00	1,360.00	1,360.00	1,360.00			
4	Spring / Fall Cleanup - Separate Organics Collection															
	2 weeks each season	9,147.60						9,147.60								
5	Christmas Tree Collection			1,455.30												
		\$ 37,075.50	\$ 27,927.90	\$ 29,383.20	\$ 27,927.90	\$ 27,927.90	\$ 27,927.90	\$ 38,435.50	\$ 40,195.90	\$ 40,195.90	\$ 40,195.90	\$ 40,195.90	\$ 29,287.90			
* See page 1 for the monthly payment calculations for each collection type.																
Not all services are performed each month. For example, Spring and Fall Cleanup only occurs in May and November.																
For those services that Are performed in a particular month indicated, the annual cost is divided equally among each month the service occurs.																

APPENDIX A1

CONTRACTOR'S PRICING

NTD – To be incorporated from Contractor's proposal

SCHEDULE E

PRIVACY PROTECTION SCHEDULE

1. Definitions

1.1 In this Schedule,

- (a) **“access”** means disclosure by the provision of access;
- (b) **“applicable legislation”** means the Personal Information International Disclosure Protection Act and the Freedom of Information and Protection of Privacy Act;
- (c) **“contact information”** means information to enable an individual at a place of business to be contacted and includes the name, position name or title, business telephone number, business address, business email or business fax number of the individual;

2. Purpose

2.1 The purpose of this Schedule is to:

- (a) enable IWMC to comply with IWMC’s statutory obligations under the applicable legislation with respect to personal information that is collected, retained, used, or disclosed as a result of the provision of the Services; and
- (b) ensure that, as a “service provider”, the Contractor is aware of and complies with the Contractor's statutory obligations under the applicable legislation with respect to personal information that is collected, retained, used, or disclosed as a result of the provision of the Services.

3. Collection of personal information

- (a) Unless the Agreement otherwise specifies, or IWMC otherwise directs in writing, the Contractor may only collect or create personal information that is necessary for the performance of the Contractor’s obligations, or the exercise of the Contractor’s rights, under the Agreement.
- (b) Unless the Agreement otherwise specifies, or IWMC otherwise directs in writing, the Contractor must collect personal information directly from the individual the information is about.
- (c) Unless the Agreement otherwise specifies, or IWMC otherwise directs in writing, the Services must make provision to inform an individual from whom personal information is collected:
 - (i) the purpose for collecting it;
 - (ii) the legal authority for collecting it; and

- (iii) the title, business address and business telephone number of the person designated by IWMC to answer questions about the collection of personal information.

4. Integrity of personal information

- (a) The Contractor must make every reasonable effort to ensure the integrity and completeness of any personal information that comes within the custody or control of the Contractor as a result of the provision of the Services where that personal information is to be used by the Contractor or IWMC to make a decision that directly affects the individual the information is about.

5. Requests for access to personal information

- (a) If the Contractor receives a request for access to personal information from a person other than IWMC, the Contractor must promptly advise the person to make the request to IWMC unless the Agreement expressly requires the Contractor to provide such access and, if IWMC has advised the Contractor of the name or title and contact information of an official of IWMC to whom such requests are to be made, the Contractor must also promptly provide that official's name or title and contact information to the person making the request.

6. Correction of personal information

- (a) Within 7 days of receiving a written direction from IWMC to correct or annotate any personal information, the Contractor must annotate or correct the information in accordance with the direction.
- (b) When issuing a written direction under section 8, IWMC must advise the Contractor of the date the correction request to which the direction relates was received by IWMC in order that the Contractor may comply with section 10.
- (c) Within 7 days of correcting or annotating any personal information under section 8, the Contractor must provide the corrected or annotated information to any party to whom, within one year prior to the date the correction request was made to IWMC, the Contractor disclosed the information being corrected or annotated.
- (d) If the Contractor receives a request for correction of personal information from a person other than IWMC, the Contractor must promptly advise the person to make the request to IWMC and, if IWMC has advised the Contractor of the name or title and contact information of an official of IWMC to whom such requests are to be made, the Contractor must also promptly provide that official's name or title and contact information to the person making the request.

7. Protection of personal information

- (a) The Contractor must protect personal information by making reasonable security arrangements against such risks as unauthorized access, collection, use, disclosure or disposal, including any expressly set out in the Agreement.

8. Storage and access to personal information

- (a) Unless IWMC otherwise directs in writing, the Contractor must not store personal information outside Canada or permit access to personal information from outside Canada.

9. Retention of personal information

- (a) Unless the Agreement otherwise specifies or unless IWMC directs otherwise in writing, the Contractor must retain personal information for at least one year following the date of its use and securely dispose of personal information no later than three years after its use.

10. Use of personal information

- (a) Unless IWMC otherwise directs in writing, the Contractor may only use personal information if that use is required for the performance of the Services.

11. Disclosure of personal information

- (a) Unless IWMC otherwise directs in writing, the Contractor may only disclose personal information inside Canada to any person other than IWMC if the disclosure is for the performance of the Contractor's obligations, or the exercise of the Contractor's rights, under the Agreement.
- (b) Unless the Agreement otherwise specifies or IWMC otherwise directs in writing, the Contractor must not disclose personal information outside Canada.

12. Notice of foreign demands for disclosure

- (a) In addition to any obligation the Contractor may have to provide the notification contemplated by section 6(1) of the *Personal Information International Disclosure Protection Act*, if in relation to personal information in the custody or under the control of the Contractor, the Contractor:
 - (i) receives a foreign demand for disclosure;
 - (ii) receives a request to disclose, produce or provide access that the Contractor knows or has reason to suspect is for the purpose of responding to a foreign demand for disclosure; or

- (iii) has reason to suspect that an unauthorized disclosure of personal information has occurred in response to a foreign demand for disclosure,

the Contractor must immediately notify IWMC and, in so doing, provide the information described in section 6(2) of the *Personal Information International Disclosure Protection Act*. In this section, the phrases “foreign demand for disclosure” and “unauthorized disclosure of personal information” will bear the same meanings as in section 2(1) of the *Personal Information International Disclosure Protection Act*.

13. Notice of unauthorized disclosure

- (a) If the Contractor knows that there has been an unauthorized disclosure of personal information in the custody or under the control of the Contractor, the Contractor must immediately notify IWMC. In this section, the phrase “unauthorized disclosure of personal information” will bear the same meaning as in section 2(1) of the *Personal Information International Disclosure Protection Act*.

14. Inspection of personal information

- (a) In addition to any other rights of inspection IWMC may have under the Agreement or under statute, IWMC may, at any reasonable time during normal business hours and on reasonable notice to the Contractor, enter on the Contractor’s premises to inspect any personal information in the custody or control of the Contractor as a result of its provision of the Services, and any of the Contractor’s information management policies or practices relevant to the Contractor’s management of personal information in connection with the Services or the Contractor’s compliance with this Schedule, and the Contractor must permit, and provide reasonable assistance to, any such inspection. The inspection will be conducted in a manner as not to interfere unreasonably with Contractor’s business operations and is subject to Contractor’s reasonable confidentiality and security policies, procedures and requirements.

15. Compliance with the applicable legislation and directions

- (a) The Contractor must in relation to personal information comply with:
 - (i) the requirements of the applicable legislation to the Contractor as a “service provider”, including any applicable order under the applicable legislation; and
 - (ii) any direction given by IWMC that is permitted or required to be given under this Schedule.
- (b) The Contractor acknowledges that it is familiar with the requirements of the applicable legislation governing personal information that are applicable to it as a “service provider”.

16. Notice of non-compliance

- (a) If for any reason the Contractor does not comply, or anticipates that it will be unable to comply, with a provision in this Schedule in any respect, the Contractor must promptly notify IWMC of the particulars of the non-compliance or anticipated non-compliance and what steps it proposes to take to address, or prevent recurrence of, the non-compliance or anticipated non-compliance.

17. Termination of Agreement

- (a) In addition to any other rights or remedies which IWMC may have under the Agreement or otherwise at law, IWMC may, upon any failure of the Contractor to comply with this Schedule in a material respect, declare such non-compliance to be an Event of Default and terminate the Services, or a component thereof, and/or the Agreement, in accordance with Section 11.1(a) of the Agreement.

18. Interpretation

- (a) In this Schedule, references to sections by number are to sections of this Schedule unless otherwise specified in this Schedule.
- (b) Any reference to the “Contractor” in this Schedule includes any subcontractor or agent retained by the Contractor to perform obligations under the Agreement and the Contractor must ensure that any such subcontractors and agents comply with this Schedule.
- (c) The obligations of the Contractor in this Schedule will survive the termination of the Agreement and will only expire when the Contractor no longer has any personal information generated as a result of the Services in its custody or control.
- (d) If a provision of the Agreement (including any direction given by IWMC under this Schedule) conflicts with a requirement of the applicable legislation or an applicable order under the applicable legislation, the conflicting provision of the Agreement (or direction) will be inoperative to the extent of the conflict.
- (e) The Contractor must comply with the provisions of this Schedule despite any conflicting provision of this Agreement or, subject to section 30, the law of any jurisdiction outside Canada.
- (f) Nothing in this Schedule requires the Contractor to contravene the law of any jurisdiction outside Canada unless such contravention is required to comply with the applicable legislation.

SCHEDULE D
MONTHLY DIESEL FUEL AMOUNT TABLE *
- EASTERN KINGS REGION
(Submitted pursuant to Section 7.3 of the Agreement)

Day	Zone	Truck License #	Start time	End time	Operating Minutes	Kms Traveled
Monday						
(add line items as required)						
Tuesday						
Wednesday						
Thursday						
Friday						

Total Operating Minutes	
Total Kms Traveled	
Weekly Diesel Fuel Amount (Total Kms / 4.5 kms x 3.8 litres)	
Monthly Diesel Fuel Amount (Weekly x 52 / 12)	
Contractor Name	
Submitted By (Name)	
Signature	
Date	

* To be submitted to IWMC within 30 days of commencement of the Term, based on collection route actual travel experience.

**SCHEDULE B
WORK SPECIFICATION**

1.	CONTRACTOR RESPONSIBLE FOR THE WORK	1
2.	PERFORMANCE OF THE WORK	1
2.1	Collection and Transportation of Source Separated Solid Waste and Organics.....	1
2.2	Undefined Work.....	1
2.3	Provision of the Work.....	1
2.4	Standards	1
2.5	Personnel	2
2.6	Permits.....	3
3.	EQUIPMENT.....	4
3.1	Age of Contractor’s Vehicles	4
3.2	Delivery of New Vehicles	4
3.3	Number of Vehicles.....	4
3.4	Inspection of Collection Vehicles	5
3.5	Design and Construction of Collection Vehicles	5
3.6	Equipment Maintenance Requirements.....	6
3.7	Equipment or Items to be Included on Collection Vehicles.....	6
3.8	Advertising on Collection Vehicles.....	10
4.	ATTIRE, PERSONAL PROTECTIVE EQUIPMENT AND MATERIALS.....	10
4.1	General Employee Appearance and Attire	10
4.2	Personal Protective Equipment (PPE).....	10
4.3	Materials	11
5.	COLLECTION OF SOURCE-SEPARATED SOLID WASTE AND ORGANICS	11
5.1	General Procedure	11
5.2	Serviced Units	11
5.3	Non-Serviced Units	12
5.4	Containers and Placement of Containers by Resident	12
5.5	Number of Containers	14
5.6	Types of Waste and Organics to be Collected	15
5.7	Type of Waste and Organics Not to be Collected.....	16
5.8	Spring and Fall Cleanup Collection.....	17
5.9	Christmas Tree Collection	18
5.10	Collections from Multi-Unit Dwellings (Apartments).....	18
5.11	Backyard Collections.....	19
5.12	Church Properties.....	19
5.13	Curbside Inspections and Placement of Education Tags/Stickers by Contractor.....	19

5.14	Education Stickers/Tags.....	20
6.	CONTRACTOR’S PERFORMANCE OF THE WORK	20
6.1	Collection and Transportation of Source Separated Solid Waste.....	20
6.2	Contractor Responsibilities when Performing Collection and Transportation of Source Separated Solid Waste and Organics	21
7.	CONTRACTOR’S COLLECTION AND CLEANLINESS REQUIREMENTS	24
7.1	Collection and Cleanliness Procedures	24
8.	DELIVERY OF COLLECTED MATERIALS	25
9.	RECEIVING FACILITIES.....	25
9.1	Designated Facilities and Receiving Hours	26
9.2	Load Inspections at Final Disposal Facilities:	28
10.	INSPECTION, PERIODIC MONITORING, REVIEW MEETINGS	29
10.1	Periodic Monitoring.....	29
10.2	Vehicle Inspections	29
10.3	Review Meetings	29
11.	CUSTOMER SERVICE AND MISSED COLLECTIONS.....	29
11.1	Customer Service.....	30
11.2	Missed Collections.....	31
12.	REPORTING REQUIREMENTS	32
12.1	Daily Drivers Report.....	32
12.2	General Information	32
12.3	Incident Reporting.....	33
12.4	Monthly and Annual Reporting	33

APPENDICES

- APPENDIX B1 - Collection Vehicle Inspection Report
- APPENDIX B2 - Daily Driver's Report

WORK SPECIFICATION

1. CONTRACTOR RESPONSIBLE FOR THE WORK

IWMC's rights of review, acceptance, approval, or confirmation of compliance with respect to any aspect of the Work will be for IWMC's benefit only, and no acceptance, approval or confirmation of compliance by IWMC's Solid Waste Collection Representative or other representative of IWMC shall in any way relieve the Contractor of its obligation and responsibility for all aspects of the Work except as may be expressly set out in this Agreement.

2. PERFORMANCE OF THE WORK

2.1 Collection and Transportation of Source Separated Solid Waste and Organics

- a) The Contractor will perform the Work in compliance with the requirements and standards as set out in this Schedule B – Work Specification including in a manner which:
 - i. is efficient and comprehensive;
 - ii. facilitates and promotes a collaborative working relationship with IWMC, its employees and contractors (including other contractors that collect and transport Source-Separated Solid Waste);
 - iii. is safe for all persons, including employees of the Contractor, IWMC and residents;
 - iv. does not create environmental hazards; and
 - v. applies safe working practices including using recognized risk assessment and management systems.

2.2 Undefined Work

The Contractor will, as part of the Work, provide such ancillary and additional services that may not be expressly described in this Agreement, but which are reasonably required so as to achieve the performance, standards and specifications set out in this Agreement.

2.3 Provision of the Work

The Contractor will at all time during the Term or any Extension Term(s) provide the Work in accordance with the order of precedence as set forth in Section 1.3 of the Agreement.

2.4 Standards

In accordance with the other provisions of this Agreement, the Contractor will at all time during the Term, or any Extension Term(s), provide the Work:

- a) in accordance with the standards set out in this Schedule;

- b) in compliance with all Applicable Laws;
- c) in a manner based on sound technical and operational procedures in accordance with good industry practice; and
- d) to the same standards that an experienced, prudent, and knowledgeable long-term contractor performing similar collection and transportation of source-separated solid waste and organics would employ, taking into account the age and use of any comparable equipment.

If one or more of the foregoing standards is applicable to any particular component of the Work, then the highest of such standards will apply, provided that in all cases such standard or standards will be applied taking into account the age, use and reasonable wear and tear on any equipment used to provide the Work.

2.5 Personnel

- a) The Contractor will at all times during the Term, or an Extension Term(s), employ a sufficient number of appropriately qualified, licensed, trained, experienced and competent employees to perform the Work in compliance with this Agreement. The Contractor will replace employees to whom IWMC reasonably objects, taking into account the employee's performance, behavior, and the effect of that employee's performance on the Work.
- b) As part of its staffing complement to perform the Work, the Contractor shall provide the following personnel at a minimum, who shall have as part of their role, the corresponding duties and training:
 - i. at least 1 manager or supervisor of the Contractor's collection routes (who may be the Contractor's Solid Waste Collection Representative), who shall be a Key Individual and who shall:
 - (1) supervise the administrative representative as required;
 - (2) supervise the drivers and collectors of the Contractor's collection vehicles;
 - (3) receive and respond to inquiries from IWMC's Solid Waste Collection Representative or other IWMC representatives who have been designated, in writing, to the Contractor;
 - (4) oversee service to customers;
 - (5) oversee the monitoring of the Contractor's various Collection and Transportation routes; and,
 - (6) have supervisory skills and experience, collection and transportation knowledge and experience, public relations and customer service training, and knowledge of IWMC's Source-Separated Solid Waste & Organics Collection system, knowledge of IWMC's

Source-Separated Solid Waste and Organics education, tagging, rejection, information and reporting policies, and requirements and health and safety training.

- ii. at least 1 administrative representative, who shall be a Key Individual and who shall:
 - (1) receive communications from Residents, IWMC's Customer Service Center, and other IWMC staff with respect to Customer Service and work to resolve inquiries and complaints, as set forth in Section 11 of this Schedule B;
 - (2) receive instructions from IWMC's Solid Waste Collection Representative (or other IWMC representatives who have been designated, in writing to the Contractor) and communicate such instructions to the appropriate Contractor's supervisory staff and employees operating the Contractor collection vehicles and equipment;
 - (3) maintain records, compile reports and information, prepare and submit daily drivers reports and complete the Contractor's administrative needs as required by this Schedule B; and,
 - (4) have training and knowledge in customer service, IWMC's Source-Separated Solid Waste Collection system and knowledge of IWMC's Solid Waste collection programs including education, tagging, rejection, and, information and reporting policies and requirements.
- iii. a sufficient number of drivers and collectors to complete the Work as set forth in this Agreement, including this Schedule B, and each driver or collector shall have training including training with respect diversity and inclusion, IWMC's Source-Separated Solid Waste and Organics Collection system, health and safety requirements, basic customer service requirements, including how to effectively respond to inquiries from the public, and how to apply IWMC's policies and requirements of the Waste Watch Program concerning education, information gathering and reporting, and the curbside tagging/stickering and rejection of Source-Separated Solid Waste and Organics.

2.6 Permits

Except as may be expressly provided otherwise in this Agreement, the Contractor will obtain all Permits required for the performance of the Work, including, but not limited to, permits for operation of the Contractor's collection vehicles. The Contractor will:

- a) keep IWMC's Solid Waste Collections Representative informed of pertinent matters with respect to Permits for which the Contractor is responsible;
- b) upon request from IWMC's Solid Waste Collection Representative, provide to IWMC copies of all documentation and correspondence relating to such Permits.

Except as may be expressly provided otherwise in this Agreement, the Contractor assumes all risk, costs

and liabilities arising in relation to Permits for which the Contractor is responsible including the inability to obtain Permits, conditions of obtaining Permits, or amendments to Permits as may be required. IWMC will, at its own cost, provide, or cause to be provided to the Contractor, such information within IWMC's possession, and co-operate with the Contractor, as the Contractor may reasonably require in relation to Permits for which the Contractor is responsible, and shall execute such applications as are required to be in IWMC's name, to enable the Contractor to obtain, maintain or renew Permits for which the Contractor is responsible or to demonstrate compliance with any Permits.

3. EQUIPMENT

3.1 Age of Contractor's Vehicles

- a) At the commencement of the Operational Term at least 80% of the collection vehicles used by the Contractor to perform the Work shall be model year 2019 or newer. The remainder shall be 2015 or newer.
- b) At any time during the Operational Term, ages of the collection vehicles used by the Contractor to perform the Work shall adhere to this ratio of 80%/20% with the respective model years being increased by one year on each one year anniversary date of the commencement of the Operational Term.

3.2 Delivery of New Vehicles

IWMC and the Contractor shall, both parties acting reasonably, determine a delivery schedule for any new Contractor collection vehicles that the Contractor may require in order to meet the requirements of Section 3.1 (a) of this Schedule A. Notwithstanding this such delivery schedule shall ensure that any new collection vehicles are delivered to the Contractor no later than six (6) months following the commencement of the Operational Term. The responsibility, to provide the Work in accordance with this Agreement during any delay in the delivery of any collection vehicles including any costs and expenses incurred as a result of the delay, shall be the Contractor's.

3.3 Number of Vehicles

- a) It is the responsibility of the Contractor to determine the number of collection vehicles required, and their allocation, in order to perform the Work. The number of collection vehicles must also adequately address daily, weekly and/or seasonal variations in the amount of Source Separated Solid Waste or Organics placed for collection by Residents at Serviced Units, as well as the projected growth in Serviced Units. Without limiting the generality of the foregoing, the Contractor will ensure it has sufficient numbers of collection vehicles in order to provide the additional services required by IWMC, in accordance with this Agreement.
- b) Should IWMC, acting reasonably, determine the Work is not being performed by the Contractor in accordance with this Agreement and that the penalties imposed under Section 14 of the Agreement are not resulting in the correction of such non-performance, IWMC may, at any time

during the Operational Term, require that the Contractor increase the number of collection vehicles to a level that ensures the Work is being performed correctly. Such increase in the number of collection vehicles and the related staffing costs shall be at the cost and expense of the Contractor.

- c) At the commencement of the Operational Term, the Contractor shall submit to IWMC a list, including make, model, year, identification numbers, license numbers, of the Contractor's collection vehicles to be used by the Contractor in performing the Work. The Contractor must provide these details to IWMC for each new Contractor's collection vehicle that the Contractor wishes to use to perform the Work. IWMC will internally register these collection vehicles and enter the information within its computer systems to facilitate the Contractor's use of the collection vehicles at the designated Receiving Facilities. The Contractor is responsible to obtain and maintain all registration and permits with respect to the Contractor's collection vehicles.

3.4 Inspection of Collection Vehicles

- a) IWMC shall review and approve the Contractor's proposed collection vehicles prior to the commencement of the Work and at any time during the Operating Term and Extension Term(s). If a collection vehicle does not meet one of the requirements set forth in this Schedule B, IWMC may reasonably request that the Contractor make alterations to the collection vehicle such that it meets the requirements set forth in this Schedule B, or replace such collection vehicle, and such alterations or replacement shall be at the Contractor's cost and expense.

3.5 Design and Construction of Collection Vehicles

- a) The collection vehicles must be appropriately designed and constructed in order to perform the Work.
- b) The collection vehicles are to be constructed such that the risk of depositing waste and organics onto a roadway during the performance of the Work is eliminated.
- c) The Contractor shall ensure that the moisture content of Organics is considered in the design and construction of collection vehicles. Liquid or moisture shall not be permitted to drain or spill from collection vehicles.
- d) The collection vehicles shall be designed so that the maximum height in the dumping position is compatible with, and shall not cause damage to, any Receiving Facilities.
- e) All collection vehicles shall be designed so as to negate the effect of weather on the Sourced Separated Solid Waste and Organics during transportation.
- f) Carts used for the storage and collection of Waste and Organics must be emptied into the Contractor's Waste and Organics collection vehicle using Lifters. It is the responsibility of the Contractor to procure and install Lifters that meet the requirements of this Agreement,

including this Schedule B, such that the Lifters ensure safe and effective operation of the collection of Waste and Organics and prevent damage to the Carts.

Note: Attachment 4 shows an Industrial Cart Tipper model C220 which is a universal tipper that handles both domestic and European style carts (This is a sample only). IWMC currently utilizes 240 litre and 140 litre SSI Schaefer and IPL 240 litre and 120 litre carts. Contractors must ensure that the cart tipper can operate with both types of carts. The purpose of Attachment 4 is to highlight the cycle time which is measured from the point the cart leaves the ground to the point the cart is returned to the ground (no stopping). This cycle must be between 8-10 seconds in duration. The maximum weight limit of the carts is 220 lbs. Attachment 4 outlines the specifications for model C220 which is able to handle 120, 140 and 240 litre cart sizes. All tippers shall be set to lift a maximum of 220 lbs and have a lift cycle of no less than 8 seconds.

3.6 Equipment Maintenance Requirements

- a) All equipment, including collection vehicles, supplied by the Contractor must be kept reasonably clean at all times during and after the Work is performed.
- b) The equipment used for the Work, including collection vehicles, shall be well maintained, mechanically and operationally sound, clean, rust and dent free in appearance, and painted in the Contractor's company colors. In determining the painting schedule, the appearance shall be the criteria for each vehicle. Vehicles that are losing paint or have rust on a visible portion of their surface will be required to be painted.
- c) If the Contractor's equipment, including collection vehicles, does not meet the requirements of 3.6(a) and (b), then IWMC, acting reasonably and in adherence to the requirements of this Agreement, IWMC shall provide written notice to the Contractor outlining IWMC's concerns. The Contractor shall review the content of the notice and, within 7 days, provide a written response to IWMC regarding the Contractor's proposed resolution to the issues addressed in the notice. IWMC shall, within 7 days, respond in writing to the Contractor that the proposed means of addressing the issue is acceptable, or that IWMC requires the Contractor to perform further cleaning or maintenance. Once agreed, the Contractor shall carry out the corrective procedures promptly. If the Contractor disputes IWMC's requirement for cleaning or maintenance, the Contractor shall follow the dispute resolution process set forth in the Agreement.

3.7 Equipment or Items to be Included on Collection Vehicles

- a) All collection vehicles used for the Work must have the vehicle information (e.g., name of Contractor, vehicle year, make and model, licence number, type/size, color) and TARE weight registered with IWMC. Each collection vehicle will have an identification number issued by IWMC which is to be displayed on the left front of the vehicle in characters at least 10 cm in height. The color of the lettering on each vehicle will be such that it contrasts with the color of the collection vehicle to facilitate its visibility at each Receiving Facility scale.

- b) The lighting for collection vehicles shall comply with Applicable Laws. Additionally, collection vehicles shall be equipped with strobe warning lights mounted at the left rear side of the collection vehicle, and such lights shall be operated at all times during the performance of the Work.
- c) Collection vehicles must be equipped with appropriate safety equipment as set forth in Applicable Laws, including, but not limited to, emergency fire extinguishing apparatus, oil-absorbing agent, clean-up equipment for debris spillage including a broom and a shovel, and a display on rear panels or other such prominent location indicating that “THIS VEHICLE MAKES FREQUENT STOPS”.
- d) Collection vehicles shall have automatic vehicle locator technology (“AVLT”) installed and such AVLT shall be used as follows:
 - i. all costs and expenses associated with AVLT services and telecommunications (e.g. cellular contract, data transmission) will be managed and paid for by the Contractor including all installations, maintenance and removals on the Contractor’s collection vehicles used for the Work;
 - ii. the application must be cloud based and the data including back-ups housed in Canada;
 - iii. the AVLT shall be live/operational by no later than two months after the commencement of the Operational Term;
 - iv. the Contractor, at its cost and expense, shall coordinate AVLT demonstration and training sessions for IWMC, during the time period set forth in Section 3.7(d)(iii);
 - v. training materials such as training modules and user manuals are to be provided to IWMC by the Contractor;
 - vi. the Contractor shall ensure that the vendor of the AVLT shall be reasonably available to provide help/access/support to IWMC;
 - vii. IWMC will require at a minimum, 3 AVLT user licenses, with such licenses having the same level of access as is provided by the AVLT vendor to the Contractor for the collection vehicles used for the Work;
 - viii. all costs and expenses associated with IWMC's access to the AVLT during the Term or the Renewal Term, will be paid for by the Contractor;
 - ix. the Contractor will provide IWMC with secure, web-browser access to the AVL output data;
 - x. the AVLT must have security functions incorporated which safeguard the data collected

- against accidental or unauthorized access, disclosure, use, modification, and deletion;
- xi. the AVLT shall include all hardware, software, instructions and manuals necessary to operate the AVLT for the collection vehicles used for the Work;
 - xii. the AVLT shall be owned by the Contractor for the Term of the Agreement, including any Extension Term(s), but the data outputted by the AVLT shall be used by IWMC during the Term or any Renewal Term and after the expiry or termination of the Agreement;
 - xiii. the AVLT must be tamper resistant, durable and rugged in design;
 - xiv. it is the Contractor's responsibility to ensure the AVLT is functioning in accordance with this Agreement at all times during the Operational Term;
 - xv. the Contractor must report all damages and malfunctions of AVLT immediately (within 24 hours of the Contractor becoming aware of the damage or malfunction) to IWMC's Solid Waste Collection Representative;
 - xvi. the Contractor shall provide at least 3 days written notice to IWMC of planned maintenance or upgrades to the AVLT that may interrupt availability of IWMC's use of the AVLT;
 - xvii. the Contractor must ensure that any damages or malfunctions with the AVLT are remedied within 7 days, or if unable to be remedied within this time frame, after the vendor or Contractor taking all commercially reasonable measures to address such damages or malfunctions, the Contractor must inform IWMC's Solid Waste Collection Representative of the expected time frame for resolution;
 - xviii. the Contractor must have in place, and provide IWMC a description of, back up procedures to ensure the Work continues in the event of a planned or unplanned outage of the AVLT (e.g. the Contractor should have in place and indicate how many back-up AVLT units are available as replacements in the event of a malfunction or planned repair);
 - xix. the AVLT shall include a base map which shall identify IWMC's geographic boundaries and this base map information may be accessed from the Government of Prince Edward Island enterprise GIS platform directly or through files that may be periodically provided by IWMC;
 - xx. the base map to be used must be able to accept file types or layers such as SHAPEFILE or KML from IWMC;
 - xxi. all historical, raw data collected by the AVLT must be accessible through an API to a vendor database or exportable to IWMC, at a minimum as an Excel-compatible file;

xxii. the AVLT must:

- (1) ensure that all Contractor collection vehicle activities are time and location stamped;
- (2) be able to monitor route progress (directional tracking) via on-screen display of position and/or path;
- (3) be able to detect and notify if a collection vehicle ceases to operate mechanically or perform any of the functions required by this Agreement;
- (4) automatically power on and begin data collection/transmission when the collection vehicle ignition is engaged;
- (5) be able to monitor current position via on-screen display of position and/or path;
- (6) be able to display vehicle movement;
- (7) be able to identify and show the position of the collection vehicle on 60 second (1 minute) intervals or less;
- (8) be able to display all vehicle stopping/starting data;
- (9) record and report distances traveled by collection vehicles on any given day and total distances since the vehicle became operational;
- (10) be able to provide vehicle location by street address;
- (11) be able to provide vehicle location by GPS coordinates;
- (12) have the ability to collect data if the AVLT unit is "offline" (i.e. no data loss due to lack of connection);
- (13) have the following basic functions: Zoom in, Zoom Out, Pan, Center, selection by rectangle, and Identify;
- (14) be able to perform the following search functionality: map an address and map an intersection;
- (15) be able to display layers of GIS data;
- (16) be able to display the map legend;
- (17) be able to identify the Contractor's collection vehicles expected routes;
- (18) be able to identify (in real-time) the completed and non-completed areas visually;
- (19) be able to display all data for no less than 3 months in the software interface;

- (20) provide data older than 3 months (including all data collected during the Term, or any Renewal Term), either through the solution itself or by specifically requested report;
- (21) provide playback of the path of a vehicle on-screen for a selectable time period and/or selected GPS location (or address) within the previous 12 months;
- (22) provide playback of the vehicle's individual movements and statuses on-screen;
- (23) provide playback of the vehicle's individual movements and statuses on-screen for the previous 12 months;
- (24) shall display all query results on-screen; and,
- (25) allow formatted printing of both tabular data and mapped data queried.

3.8 Advertising on Collection Vehicles

- a) Subject to Section 3.8(b) and (c) of this Schedule B, the Contractor is prohibited from having any type of advertising affixed to or carried on the Contractor's collection vehicles.
- b) The Contractor shall affix to its collection vehicles the name of the Contractor, a business telephone number and Internet address, and only such other additional information as approved in advance by IWMC's Solid Waste Collection Representative in writing.
- c) IWMC reserves the right to place messaging on the Contractor's collection vehicles promoting IWMC's solid waste resource management programs and services. If requested, the Contractor will place such appropriately designed and sized labels, signs or decals on each collection vehicle as directed by IWMC. The costs and expenses associated with such messaging shall be borne by IWMC.

4. ATTIRE, PERSONAL PROTECTIVE EQUIPMENT AND MATERIALS

4.1 General Employee Appearance and Attire

- a) The employees of the Contractor who are performing the Work shall be neat and well-groomed in appearance, wear appropriate attire during the performance of the Work.
- b) Appropriate attire consists of a uniform of the Contractor or, at a minimum, a reasonably clean shirt and pants or coveralls covering the same areas of the body as the Contractor's uniform would. Employees of the Contractor must wear long pants and a shirt while performing the Work.

4.2 Personal Protective Equipment (PPE)

- a) Employees shall wear PPE when performing the Work, consisting of:

- i. appropriate gloves;
 - ii. safety vests or other high visibility clothing (or equivalent high visibility markings on jackets, rain suits, coveralls); and,
 - iii. safety footwear (i.e., steel-toed and slip resistant footwear);
- b) In addition to the PPE items listed above in Section 4.2(a), a hard hat must be worn by employees while inside a Receiving Facility which requires a hard hat (e.g., PEI Energy Systems). Safety glasses and hearing protection may also be required at Receiving Facilities.
- c) The PPE requirements set forth in this Section 4.2 are the minimum PPE requirements and the Contractor must meet, for the duration of the Operational Term and any Extension Term(s), all PPE requirements applicable to the performance of the Work as set forth in any Applicable Laws.
- d) It is the responsibility of the Contractor, at its sole cost and expense, to ensure its employee performing the Work are provided with and wear appropriate attire and PPE as set forth in this Schedule B (the “**Personal Protective Equipment**” or “**PPE**”).

4.3 Materials

Other than the carts for the Source Separated Solid Waste and Organics, all materials and equipment necessary for the performance of the Work, whether required for repair, maintenance, or the general operation of the Contractor’s collection vehicles or equipment, shall be the responsibility of the Contractor.

5. **COLLECTION OF SOURCE-SEPARATED SOLID WASTE AND ORGANICS**

5.1 General Procedure

- a) This Section 5 of Schedule B sets forth the general nature of serviced units from which the Contractor shall collect the Source-Separated Solid Waste and Organics, Spring and Fall Cleanup materials, and discarded Christmas trees, along with the guidelines under which Source-Separated Solid Waste and Organics are to be collected including the receptacles into which the Source-Separated Solid Waste and Organics are required to be placed in order to warrant collection.

5.2 Serviced Units

- a) The types of properties to which the Contractor shall provide the Collection and Transportation of Source-Separated Solid Waste and Organics are all types of residences including:
- i. single unit, detached, residential dwellings including mobile/mini homes;
 - ii. multi-unit dwellings (apartments and condominiums);

- iii. row house or townhouse dwellings or condominiums of similar configuration with street or road frontage;
- iv. Seasonal residences (cottages); and
- v. Certain church properties as specified by IWMC.

5.3 Non-Serviced Units

- a) The types of properties to which the Contractor shall not provide the Collection and Transportation of Source-Separated Solid Waste and Organics are:
 - i. Industrial, Commercial and Institutional (IC&I) properties. Note: Waste and Organic material from a small business in a home is allowed in the residential waste or organic carts provided there is no excess beside the cart.

5.4 Containers and Placement of Containers by Resident

- a) A resident means the owner, occupant, lessee, tenant, or the person in charge of a Serviced Unit and includes the person(s) assessed for the property pursuant to the Assessment Act or other relevant provincial regulations (the “**Resident**”).

A container for Waste means those containers, as described more fully in Section 5.4(d) of this Schedule B (a “**Waste Container**”).

A container for Organics means those containers, as described more fully in Section 5.4(e) of this Schedule B (an “**Organics Container**”).

- b) Residents, and not the Contractor, are responsible for:
 - i. A 240 L (120 L or 140 L) black waste and green organics cart provided by IWMC. Most IWMC carts have a serial number and “Property of IWMC” stamped onto them unless they are original carts that were provided when the Waste Watch program began thirty years ago. (Note: The Manufacturer of the carts presently is either SSI Schaefer or IPL. IWMC reserves the right to change the brand of cart utilized at any time throughout the Operational term or extended term to one that is similar in specifications);
 - ii. maintaining Waste and Organics carts in good repair and in sanitary condition;
- c) With respect to the placement of Waste and Organics, Residents shall place:
 - i. waste and organics only in containers of the type, and meeting the standards, set forth in this Schedule B;

- ii. the applicable Waste or Compost cart (and containers/bags for excess waste or organics or bundles), curbside or roadside of the Serviced Unit at which the Waste and Organics has been generated, and under normal weather conditions, carts (and containers / bags / bundles) must be within 1.8 metres (6 feet) of the curb or roadway. During winter conditions, this distance is increased to within 5.5 metres (18 feet) of the curb or roadway. **Contractors are advised that this is a guideline for residents only. Within reason, collection must be provided if the placement is within range of this guideline.** For example, if a cart is within 8 feet or 20 feet of the curb or roadway, it must be collected.

d) Waste Containers may be:

- i. A 240 L (or 120 L or 140 L) Black Waste Cart provided by IWMC. Maximum cart capacity is 220 lb (100 kg).

Containers for Excess Waste may be:

- ii. plastic or metal;
 - (1) a total weight each of no more than 50 lbs (22 kg) including the can and contents; and,

Bags for Excess Waste may be:

- iii. a disposable, clear plastic bag, and such bag shall be:
 - (1) securely tied;
 - (2) thick (strong) enough as to reduce breakage, tearing or splitting upon collection;
 - (3) a total weight each of no more than 50 lbs(22 kg) including contents;

Bundles:

- iv. Excess waste items may be bundled. Each bundle must not be heavier than 50 lbs. (22 kg) or greater than 4 feet (1.2 m) for any dimension.

e) Permitted methods for Residents to place Organics by the curbside are:

- i. A 240 L (120 L or 140 L) Green (Organics) Cart provided by IWMC. Maximum cart capacity is 220 lb (100 kg).

Containers for Excess Organics may be:

- ii. plastic or metal;
- iii. a total weight each of no more than 50 lbs (22 kg) including the can and contents; and,

Bags for Excess Organics may be:

- vi. heavy, kraft paper bags, each weighing no more than 50 lbs. (22 kg), including contents, that are suitable for leaf and yard waste and suitable to contain the material without spillage or bag breakage;
- vii. bags that are certified as compostable by, and bearing the logo stamp of, either the BPI or BNQ certification organization. Each bag must weigh no more than 50 lbs. (22 kg) and be suitable to contain the material without spillage or bag breakage; and,

Bundles:

- vii. Excess Organics may be in bundles (e.g., branches and twigs). Each bundle must be securely tied and weigh no more than 50 lbs. (22 kg), with no individual item or bundle greater than 4 feet (1.2 m) for any dimension.

5.5 Number of Containers

a) The following are the allowable number of Waste Containers for Serviced Units:

- i. for each Bi-Weekly Waste Collection,
 - (1) one Waste Cart, provide by IWMC;
 - (2) Up to two additional containers, bags, bundles or items as set forth in Section 5.4(d), and meeting the requirements of Section 5.4(d) of this Schedule B,

Note: During regular weekly collections the Contractor is not required to provide service at an address where no cart provided by IWMC is evident, unless otherwise notified by IWMC. In all circumstances Drivers and Collectors should use good judgement in determining whether service is warranted (e.g., collect cold ashes set out for collection without a cart), and should provide service except in cases there is a clear and identifiable reason to not collect the material.

b) The following are the allowable number of containers for Organics for Serviced Units:

- i. For each Bi-Weekly Collection;
 - (1) one Organics Cart provided by IWMC;
 - (2) up to two additional containers, bags, bundles or items as set forth in Section 5.4(e),

and meeting the requirements of Section 5.4(e) of this Schedule B,

Note: During regular weekly collections the Contractor is not required to provide service at an address where no cart provided by IWMC is evident. But, Drivers and Collectors should use judgement in determining whether service is warranted (e.g., collect cold ashes set out for collection without a cart).

5.6 Types of Waste and Organics to be Collected

- a) The types of materials generally to be collected as Waste under this Agreement include, but are not limited to:
 - i. Items included in IWMC's sorting guide (See Attachment 2) and IWMC's sorting guide at <https://iwmc.pe.ca/>;
 - ii. crockery and glassware, floor sweepings, discarded clothing and furnishings, non-recyclable plastic, non-recyclable packaging, non-repairable household goods and other household waste placed properly in carts/containers/bags or bundles;
 - iii. ashes and soot that contain plastics, glass or metal and are completely cold should be placed in clear plastic disposable bags securely tied or cardboard boxes; and
 - iv. other items not specifically designated as Waste and not excluded elsewhere in this Schedule B, including exclusions listed in Section 5.7, but that IWMC may, in its sole but reasonable discretion, during the Term or any Renewal Term, determine to be Waste;

- b) The types of materials generally to be collected as Organics under this Agreement include, but are not limited to:
 - i. Items included on IWMC's sorting guide (See Attachment 2) and IWMC sorting guide at <https://iwmc.pe.ca/>;
 - ii. food waste including fruit and vegetable peelings, table scraps, meat, poultry and fish, shellfish, dairy products, cooking oil, grease and fat, bread, grain, rice and pasta, bones, egg shells, coffee grounds and filters, tea leaves and bags placed together in carts/containers/paper bags;
 - iii. leaf and yard waste including weeds, dandelions, leaves, brush, twigs, house and garden plant waste placed in cart/containers/paper bags;
 - iv. branches and bushes tied in bundles;
 - v. boxboard including cereal, shoe, cracker, cookie and baking product boxes, toilet paper rolls and paper towel rolls and other boxboard items (no plastics) placed together in Cart/containers/paper bags;

- vi. soiled and non-recyclable paper including food napkins, paper towels, compostable paper wrap, paper plates and cups (no Styrofoam), a few sheets of newspaper or newsprint to wrap wet food waste animal/pet feces, sugar, flour and potato paper bags (remove any plastics) placed together in Cart/containers/paper bags;
- vii. ashes and soot (containing no metal, plastic, glass or pressure-treated lumber) that is completely cold placed in a cardboard box or paper bag; and
- viii. natural trees used by Residents as Christmas trees, with decorations, plastic bags and stands removed;
- ix. other materials of plant or animal origin as designated by IWMC; and,
- x. other items not specifically designated as Organics and not excluded elsewhere in this Schedule B, including exclusions listed in Section 5.7, but that IWMC may, in its sole but reasonable discretion, during the Term or any Renewal Term, determine to be Organics.

5.7 Type of Waste and Organics Not to be Collected

- a) In performing the Work, the Contractor shall not collect the following materials from Serviced Units:
 - i. highly combustible or explosive materials, including but not limited to, such items as celluloid cuttings, motion picture film, oil or gasoline-soaked rags, gas containers, chemicals, acids or other combustible residues, ammunition, dynamite, or other similar material;
 - ii. waste listed or characterized as hazardous by any federal or provincial law;
 - iii. recyclables including scrap metals;
 - iv. tires;
 - v. septic tank pumpings, raw sewage or industrial sludge;
 - vi. friable asbestos or radioactive materials;
 - vii. materials resulting from Construction, Demolition or Renovation (CDR) activities (other than what will fit in the black IWMC cart);
 - viii. Waste generated from the industrial, commercial and institutional sector;
 - ix. branches and twigs greater than the allowable amount or not packaged according to the

requirements of this Schedule B;

- x. materials designated for disposal through stewardship programs (e.g., automotive lead-acid batteries, batteries, used oil, glycol, used oil and glycol containers, oil filters, light bulbs, medications, sharps (needles), paints, electrical and electronic products, agricultural plastic products, etc.;
- xi. propane tanks;
- xii. other items that IWMC may designate and communicate to the public from time to time; and
- xiii. Source-Separated Solid Waste and Organics which has not been placed for collection in the manner set out in this Schedule B.

5.8 Spring and Fall Cleanup Collection

- a) A Spring and Fall cleanup collection is provided to residents to allow for pick-up of volumes not usually collected in the regular weekly collections (a “**Spring and Fall Cleanup**”).
- b) This comprises two weeks for the collection of organic materials in the Spring and Fall. These collection weeks are determined by IWMC and published semi-annually in its collection calendar, and they are typically the first and third weeks in May and November. Spring and Fall Cleanup waste materials are collected during the regularly scheduled waste collection weeks for the months of May and November.
- c) IWMC reserves the right to alter or adjust the materials collected, and also the weekly schedule, as necessary, during the Operational or Extended terms.
- d) The Contractor is required to collect the organic materials separately and in addition to the regular weekly cart collections. All materials collected are to be delivered immediately to the appropriate final disposal facility. Contractors must collect the materials which have been approved by IWMC for a particular stream, including but not limited to those which are listed on the cleanup guidelines attached (Attachment 5).
- e) In accordance with Attachment 5, Construction, Demolition and Renovation (CDR) debris/materials are not part of Spring and Fall Cleanup. However, discretion and common sense must be exercised by drivers and collectors as there is a difference between material from a CDR project and one just looking to dispose of a limited amount of material that could be classified as CDR. The volume of this type of material is not to exceed the volume of a waste cart. The material does not need to be inside a cart for collection purposes, but it must meet other collection criteria. IWMC will continue to educate customers that CDR materials will not be collected during Spring/Fall cleanup; however, drivers and collectors should not reject

collection within supportable reasons. If drivers and collectors are faced with large quantities of CDR, they should reject the material, leave an educational tag and report the rejection on the Daily Drivers Report as outlined in Section 5.14 and 12.1.

- f) During Spring and Fall Cleanup weeks there will be elevated amounts of material to be collected, especially for the organics collections. It is the responsibility of the Contractor to provide sufficient vehicles and personnel to handle this material.
- g) The Spring and Fall Cleanup organics collection must commence on Monday and be completed by Saturday of the scheduled week.
- h) IWMC reserves the right to require the Contractor to complete an additional collection beyond the regularly scheduled cleanup period. Compensation for any such additional collections will be negotiated between the Contractor and IWMC.

5.9 Christmas Tree Collection

- a) Christmas trees are to be collected during one week each year. The week will be designated by IWMC and communicated to the Contractor. It is generally the first or second week in January. The Christmas tree collection must be completed on the scheduled week.
- b) The Christmas trees must be collected on a separate collection vehicle from the Organics (green) Cart collection.
- c) The Christmas trees collected are the property of IWMC.
- d) The Christmas trees are to be delivered to the Central Compost Facility as they are collected.
- e) IWMC reserves the right to direct the Christmas trees to be delivered to the East Prince Waste Management Facility or other approved facilities/locations.
- f) Residents are instructed to cut trees in half that are longer than 8 feet or heavier than 50 lbs. (22 kg). **Contractors are advised that this is a guideline for residents only. Within reason, collection must be provided if the placement is within range of this guideline.**

5.10 Collections from Multi-Unit Dwellings (Apartments)

- a) There may be locations where it is not possible for residents to place carts curbside due to space restrictions or for other reasons. In such cases drivers or collectors are expected to collect carts from their storage location and return them when emptied.
- b) From time to time IWMC will identify properties that have limited or restricted access due to on street parking or property location/layout and where routinely servicing these properties with a regular size truck may not be possible. In these situations, as confirmed by IWMC, the Contractor is required to provide a smaller collection vehicle that can safely service these

properties as scheduled.

5.11 Backyard Collections

- a) IWMC may approve special residential collection services, which will be forwarded to the Contractor.
- b) This may include, but is not limited to, backyard collections for residents whose medical or other condition limits their ability to place material curb side.
- c) Upon notification from IWMC of such an instance, the Contractor is required to collect the cart/containers from backyard storage area and return the emptied cart/containers to its original location.
- d) Some backyard collections are in winter months only, some are in summer months only, and some are year round as outlined in Attachment 6.

5.12 Church Properties

- a) Church properties may be approved by IWMC for residential collection. In such cases, Residential carts will be provided, and the Contractor notified to commence service at the Property. The present list of church properties is outlined in Attachment 7.

5.13 Curbside Inspections and Placement of Education Tags/Stickers by Contractor

- a) For all types of collections (bi-weekly, Spring/Fall Cleanup and Christmas Trees), prior to placing materials in the collection vehicle:
 - i. Materials placed curbside by the residents for collection in the carts/containers/bags/bundles must be inspected by the driver or collector prior to dumping it to ensure they meet IWMC's sorting guidelines for the collection being performed.
 - ii. In instances where materials are contaminated with non-conforming items, the driver or collector is to judge the level of contamination on the viewable portion of the cart/container/bag or bundle. If the contamination level appears to be greater than five percent (this percentage is subject to change by IMWC), the driver or collector shall reject the contaminated cart/container/bag/bundle and leave it curbside.
 - iii. When a cart/container/bag or bundle is rejected, the driver or collector must leave a sticker/tag with the cart/container/bag/bundle indicating the reason(s) it was rejected.
 - iv. When a cart/container/bag or bundle is rejected, the driver or collector must also record this on the Drivers Daily Report Form (see attached Appendix B2). The driver or collector shall record the civic address, the reason for rejecting the cart/container/bag or bundle.

This report must be received by IWMC's Customer Service Center at the end of each day.

- v. If the contamination level is judged to be below five percent, but there are contaminating items, the driver or collector shall empty the cart/container and accept the bag/bundle, if the appropriate bag for the stream being collected is used. The driver or collector must leave behind a tag/sticker indicating what the contaminating item(s) is/are so the resident is educated and can correct the problem for the future.

- b) After placing the materials in the collection vehicle which is set forth in 5.14(a):

- i. The driver or collector must again visually inspect the materials to see if they contain contaminating items that were not visible during the inspection prior to dumping. Drivers and collectors are not expected to remove contaminants from the collection vehicle but must leave a tag/sticker with the cart to indicate the contaminating items, in order to educate the resident so they can correct the problem in the future. The driver or collector must also record this on the Driver's Daily Report Form, as set forth in section 12.1.

5.14 Education Stickers/Tags

- a) Educational tags/stickers will be provided by IWMC.
- b) Contractors are responsible to ensure drivers and collectors have an adequate supply of tags/stickers.
- c) Tags/stickers may be picked up by the drivers at all IWMC final disposal facilities. They are also available at 110 Watts Avenue in Charlottetown.
- d) IWMC Waste Watch Program guidelines may change from time to time or new programs may be implemented. When directed by IWMC, the Contractor will be required, in conjunction with collecting the carts, to distribute educational materials/tags/stickers/handbills, etc. to individual residents. IWMC will supply the required materials and provide direction on how the educational material(s) are to be distributed to the residents.

6. CONTRACTOR'S PERFORMANCE OF THE WORK

6.1 Collection and Transportation of Source Separated Solid Waste

- a) Unless altered by IWMC in accordance with this Agreement, including this Schedule B, the Collection and Transportation of Source Separated Solid Waste by the Contractor shall occur as follows:
 - i. the Collection and Transportation of Waste once every 2 weeks (the "**Bi-Weekly Waste Collection**");
 - ii. the Collection and Transportation of Organics once every 2 weeks, and the Collection and

Transportation of Organics shall occur on the alternating week from the Bi-Weekly Waste Collection (the **“Bi-Weekly Organics Collection”**);

- iii. the Collection and Transportation of additional material for Spring and Fall Cleanup, with organics requiring separate collections for two weeks during each season, and waste materials collected during the normal waste cart collections (the **“Spring and Fall Clean-up”**);
 - iv. the Collection and Transportation of Christmas trees during one week, usually in January (the **“Christmas Tree Collection”**).
 - v. The Collection and Transportation of Special Collections from multi-units (the **“Special Collections”**).
 - vi. The Collection and Transportation of Backyard Collections (the **“Backyard Collections”**).
- b) The Contractor, unless advised by IWMC otherwise in accordance with this Agreement, shall transport the Waste collected in accordance with Section 6.1(a)(i) to PEI Energy Systems.
 - c) The Contractor, unless advised by IWMC otherwise in accordance with this Agreement, shall transport the Organics collected in accordance with Section 6.1(a)(ii) to the Central Compost Facility.
 - d) The Contractor, unless advised by IWMC otherwise in accordance with this Agreement, shall transport the Spring and Fall Clean-up material collected in accordance with Section 6.1(a)(iii) to the appropriate final disposal facility which is PEI Energy Systems or East Prince Waste Management Facility for waste and the Central Compost Facility for Organics.
 - e) The Contractor, unless advised by IWMC otherwise in accordance with this Agreement, shall transport Christmas trees collected in accordance with Section 6.1(a)(iv) to the Central Compost Facility.

6.2 Contractor Responsibilities when Performing Collection and Transportation of Source Separated Solid Waste and Organics

- a) The Contractor must collect from serviced units all Waste and Organics which are approved for collection, including but not limited to those outlined in Section 5.6.
- b) The Contractor must travel all roads, public or private, in both directions to collect carts on either side of the highway. Under no circumstances shall carts be wheeled across the roadway to the collection vehicle by drivers or collectors.
- c) In the event that, in IWMC’s sole but reasonable discretion, a public street or roadway does not offer adequate and sufficient room for the safe travel of the Contractor’s usual collection

vehicles, for example, due to its narrow width, insufficient turning areas or foliage coverage, the Contractor is still required to provide the Work utilizing, at the Contractor's sole cost and expense, a special collection vehicle sized to collect the Source Separated Solid Waste and Organics.

- d) Contractors shall provide the Work to Serviced Units located on private streets or roadways, unless the Contractor has been denied permission to access the private street or roadway by a Resident who holds such rights for denial.
- e) In cases where even a smaller vehicle is not able to provide the collection, the Contractor is responsible to provide the Work where the private street or roadway intersects with a public or private road and where the Contractor has permission to perform the Work and has adequate and sufficient room for the safe travel of the Contractor's collection vehicles, and where the resident has brought the cart/container to the intersection.
- f) The Contractor will be responsible for moving the Carts from the curb of a Serviced Unit to the side or back of the Contractor's Waste or Organics collection vehicle to facilitate placement of the Waste or Organics Carts on the Contractor's Lifters.
- g) The Contractor shall perform the Work in accordance with the following:
 - i. a normal working day shall be all days, other than:
 - (1) Saturdays, unless expressly set forth in this Schedule B;
 - (2) Sundays;
 - (3) Federal and Provincial statutory holidays unless expressly set forth in this Schedule B otherwise; and
 - (4) a day, or days, specified by IWMC, in writing, to the Contractor at any time during the Operational or Extension Term(s).
 - ii. the statutory holidays are as follows, presently:
 - (1) New Year's Day;
 - (2) Islander Day;
 - (3) Good Friday;
 - (4) Canada Day;
 - (5) Labour Day;

- (6) National Day of Truth and Reconciliation;
 - (7) Thanksgiving Day;
 - (8) Remembrance Day;
 - (9) Christmas Day: and,
 - (10) up to 2 other days that may be designated by IWMC in writing to the Contractor.
- i. unless otherwise expressly set forth in this Agreement (e.g., Statutory Holidays and Storm Days), the Collection and Transportation of Source Separated Solid Waste and Organics shall be performed Monday to Friday inclusive as scheduled.
 - ii. A normal or alternate collection working day consists of a start time of no earlier than 7:00 AM and a finish time of no later than 6:00 PM. Collections may occasionally be permitted outside these time frames provided prior approval has been granted by IWMC.
 - iii. if a statutory holiday, as set forth in Section 6.2(g)(ii), falls on the normal day the Contractor would perform the Work, the day for the performance of the Work shall be the Saturday following the statutory holiday. Work performed by the Contractor in accordance with this Section 6.2(iii) shall be performed by the Contractor at its own cost and expense.
 - iv. Collection days where, due to existing or impending weather conditions, it is questionable whether the Contractor is, or will be, able to perform the Work, IWMC shall having taken into account the present condition of the roads, the weather forecast for the areas to be collected, including current and pending snow and wind conditions, and the safety of the Contractor's collection employees, and following consultation with the Contractor Solid Waste Collection Representative, in its sole but reasonable judgement decide whether collection shall commence as scheduled for the day, or whether at any time during the day, based on changing conditions and circumstances, it should either be discontinued, or in some circumstances, commenced. The decision to proceed with or cancel collection will not necessarily follow that made by the Provincial government regarding schools and government offices, although such information will be included in IWMC's deliberations. When possible, IWMC shall endeavor to make such decisions concerning collection and convey them to the Contractor by 6:15 AM.
 - v. In the case of the cancellation of Collection and Transportation of Source-Separated Solid Waste or Organics, where IWMC determines, in accordance with Section 6.2(iv), that the Contractor is unable to perform the Work on the scheduled normal working day due to storms, weather events or road conditions, then the Contractor shall perform the Work on

the following Saturday. In the case of cancellation after the Collection and Transportation of Source-Separated Solid Waste or Organics began, where for reasons including, but not limited to storms, weather events or road conditions, IWMC, in its sole discretion, cancels the collection, in such case the portion of the route that was cancelled will be rescheduled to the following Saturday. The Contractor shall provide IWMC with clear details of what portion of the routes were completed prior to the cancellation.

- vi. In the event that collection is cancelled or delayed due to weather or holiday, and that this affects more than one collection day in the same week, the alternate collection will be provided on the Saturday of that week to those serviced units affected by the first day's cancellation or delay. Collection of all or a portion of those serviced units affected from other cancelled or delayed days on the same Saturday will be determined by IWMC in consultation with the Contractor. For any serviced units that have not received collection by the end of Saturday, their next collection will occur on their next regularly scheduled collection day, at which time the Contractor must also collect all the missed material, waiving the normal "two excess container/bag" limit.
- vii. The Contractor shall maintain the weekly collection schedule as provided by IWMC.
- viii. any changes the Contractor wishes to make to the days for the performance of the Work, or the Region, or portion of Region, in which the Work is performed on each normal working day, as set forth in its Weekly Schedule, shall be reviewed and approved by IWMC in accordance with Section 4.15 of the Agreement.
- ix. the Contractor will comply with all weighing procedures implemented at each of the Receiving Facilities including, but not limited to, providing Receiving Facility staff with:
 - (1) vehicle identification;
 - (2) the Region and Zone from which the load originated; and
 - (3) Facilitating and participating in the inspection of the loads when unloaded.
- x. the Contractor shall ensure that each of the Contractor's collection vehicles entering a Receiving Facility is weighed upon entrance and then, after unloading is weighed again prior to exiting the site.

7. CONTRACTOR'S COLLECTION AND CLEANLINESS REQUIREMENTS

7.1 Collection and Cleanliness Procedures

- a) The Contractor must not place empty carts and or containers in the ditch but must return them to an area which does not impede traffic, snow removal operations or access to the driveway. This will usually be the spot where the resident placed them for collection. On days when the wind velocity threatens to move empty carts, they should be laid prone (with wheels up) to

reduce the risk they will impede traffic or cause a safety risk. The Contractor shall place unattached covers or lids for waste or organics in, or within one (1) meter of, the same waste or organics containers from which the cover or lid originated. In some circumstances, customers may have secured carts to prevent them from blowing (tied, in a corral, etc.). Drivers and Collectors are required to replace the carts as they were.

- b) It is the Contractor's responsibility, at its cost and expense, to immediately clean up any Waste or Organics debris or liquids which have fallen or spilled onto the street, roadway or at a Serviced Unit as a result of the Contractor's performance of the Work. This includes, but is not limited to, spillage or leakage from Waste or Organics carts/containers, or the breakage of bags containing waste or heavy, kraft bags containing Organics or the disassembly of bundles of yard waste which occur due to the Contractor's employees handling of such items.
- c) IWMC, as a result of the complaint procedure set forth in this Schedule B, may require, at any time during the Operational Term, or an Extension Term(s), that the Contractor perform the cleaning services outlined in Section 7.1(b) of this Schedule B and the Contractor shall perform such cleaning services at its own cost and expense.

8. DELIVERY OF COLLECTED MATERIALS

- a) IWMC requires all materials collected as part of this Agreement to be delivered, within 24 hours of collection, to the Final Disposal Facility designated by IWMC.
- b) When residential waste is diverted from PEI Energy Systems, IWMC recognizes the Contractor may wish to consolidate loads at their own facility. IWMC reserves the right to approve or deny the consolidation of loads by the Contractor for the duration of the Operating and Extended Term(s).
- c) Load consolidations must be completed on a hard surface and protected from the weather, so that there is no weight gain to the total of the collected materials.
- d) Contractors must present IWMC with load consolidation plans for approval prior to commencing the practice.
- e) IWMC retains the right to enter the Contractors facility to inspect the process at any time.
- f) Contractors must be vigilant that consolidated loads contain only materials that are from residential collection. Co-mingling of wastes from other sources is prohibited and could be grounds for termination of the Agreement.

9. RECEIVING FACILITIES

9.1 Designated Facilities and Receiving Hours

- a) Contractors may request extended hours of operation (e.g., open earlier or stay open later) at the final disposal facilities for a particular day, but requests must be approved in advance by IWMC. Requests for extended hours must be made to IWMC no later than noon on the previous day. Every effort will be made to approve reasonable requests, but all requests may not be approved.
- b) IWMC reserves the right to amend the hours of operation for the final disposal facilities at any time throughout the Operational or Extend term(s).
- c) The Receiving Facilities designated by IWMC for the receipt of Waste and Organics are as follows:
 - i. The Primary Receiving Facility for Waste is:
 - (1) **PEI Energy Systems (incinerator).** The hours for receipt of Waste collected and transported under this Agreement are **Monday to Friday, 7:00 AM. to 4:30 PM and Saturday, 7:00 – 11:00 AM.**
 - ii. The Primary Receiving Facility for Organics is:
 - (1) **The Central Compost Facility.** The hours for receipt of Organics collected and transported under this Agreement are **Monday to Friday, 8:00 AM to 5:00 PM.**
 - iii. The Secondary Receiving Facility for Waste is:
 - (1) **The East Prince Waste Management Facility (Landfill Cell).** The hours for receipt of Waste collected and transported under this Agreement are:
 - **Winter - Monday to Friday, 8:00 AM to 4:30 PM and Saturday, 8:00 AM to 12:30 PM;**
 - **Summer – Monday to Friday, 7:00 AM to 4:30 PM and Saturday 7:00 AM to 12:30 PM**
 - iv. The Secondary Receiving Facility for Organics is:
 - (1) **The East Prince Waste Management Facility** (same as above).
 - v. The Contractor shall transport the collected Waste and Organics to the applicable Primary Receiving Facility outlined in Section 9.1 of Schedule B. IWMC may advise the Contractor to transport the Waste or Organics to a Secondary Receiving Facility for a period of time.

Contractors wishing to consolidate waste only loads prior to sending them to the Secondary Receiving Facility (e.g., Transfer Station), must receive prior approval from IWMC. All collection vehicles unloading residential loads at the Transfer Station must be weighed in and out at the Transfer Station. A report of the transactions (date and time unloaded, tonnage, etc.) must be provided to IWMC with 24 hours of the diverted loads being unloaded at the Transfer Station.

- vi. Reimbursement to the Contractor for transporting Waste or Organics to a Secondary Receiving Facility is as follows.

(1) Waste - PEI Energy Systems typically has three types of shutdowns:

Type 1 – Scheduled Spring or Fall Shutdowns. These shutdowns typically occur in April/May and October/November and last seven to ten days but depending upon how maintenance goes may last longer. This type of shutdown is part of normal operations and is scheduled. IWMC will not compensate the Contractor for any waste loads diverted to the secondary waste receiving facility (EPWMF) during scheduled shutdowns.

Type 2 – Mini Shutdowns. These shutdowns occur every 8-9 weeks. All three incinerators are shutdown at the same time (usually Sunday morning) and remain offline until usually Tuesday afternoon. These shutdowns are scheduled therefore, IWMC makes every effort to accommodate residential waste loads by diverting only commercial waste loads to the Secondary Facility. In the event that over a 12 month period (January to December), there is more than 30 tonnes of residential waste diverted to a secondary facility due to this type of shutdown, IWMC will compensate the Contractor for transporting this material to EPWMF at a rate of \$15.00 per tonne for the tonnage amount that exceeds 30 tonnes.

Type 3 – Scheduled and Unscheduled Maintenance. These shutdowns are for repairs and maintenance, equipment replacements, cleaning out metal jams, etc. IWMC makes every effort to accommodate residential waste loads by firstly diverting commercial waste loads. In the event that residential waste loads must be diverted due to this type of shutdown, IWMC will compensate the contractor for loads diverted to the secondary receiving facility at a rate of \$15.00 per tonne (subject to change by IWMC).

- (i) IWMC gives priority to residential loads going into PEI Energy Systems. IWMC makes an effort each day to ensure there is sufficient room on the receiving floor to receive residential waste for the day. In the event that residential waste must be diverted due to volume, then IWMC will compensate the Contractor for transporting the residential materials diverted at a rate of \$15.00 per tonne (subject to change by IWMC).

(2) Organics:

- (i) The Central Compost Facility does not normally require any diversion of organic materials. Should circumstances arise that cause this facility to have to divert organic material, the Contractor will not be responsible for additional costs associated with transporting diverted material to the Secondary Receiving Facility, but will be compensated at a rate to be established by IWMC at the time, based on the circumstances.

9.2 Load Inspections at Final Disposal Facilities:

a) **Inspections of Loads:**

IWMC has load quality Inspectors at each of the Final Disposal Facilities. After unloading, drivers and collectors must remain while the load is inspected. The driver or collector must present the Inspector with their Driver's Report indicating the civic addresses where contaminated carts were tipped and the contamination only noticed after tipping. Without this Driver's Report, loads that are assessed by the IWMC Inspector to contain more than the acceptable level of contamination (presently five (5) percent) by volume will either be surcharged or rejected as follows.

- i. Organics Loads which include higher than acceptable levels of contamination will be either rejected and instructed to be removed or accepted as contaminated and surcharged. Depending on the level and nature of the contamination, the Contractor may be given the choice to either incur the surcharge, or to have the load reloaded and removed from the facility. In certain cases, IWMC may determine, in its sole discretion, that a load cannot be processed at the facility and must be removed, in which instance a reloading fee will be levied against the Contractor's commercial account. (The reloading fee shall be \$100.00, subject to change by IWMC).

In instances where the Contractor has indicated their decision to remove a contaminated organics load from the facility, the removal shall be done immediately. When it is not possible to reload the contaminated load into the collection vehicle, the Contractor shall send an appropriate alternate vehicle to be loaded. Contaminated loads that are to be removed will be held for a maximum of 24 hours. Should the Contractor fail to have the load removed within that time, or should the Contractor be non-responsive to IWMC beyond 24 hours concerning whether they choose to have the load removed rather than surcharged, the entire load will be surcharged to the Contractor's commercial account, and the load then removed by IWMC, with the reloading fee and the cost of transport additionally being charged to the Contractor, along with other disposal costs.

- ii. Waste Loads which include higher than acceptable levels of contamination will be accepted as contaminated and surcharged. Re-loading is not an option for waste loads.

b) **Surcharges to Contaminated Loads**

Surcharges to loads assessed as contaminated in accordance with Section 9.2(a) will be charged to the Contractor's commercial account. The surcharge will be based on the tonnage of the load and at the prevailing IWMC mixed waste disposal fee (presently \$230.00 per tonne). A surcharge may be for 100%, 75%, 50% or 25% of a load, depending on the assessed level of contamination. If the contamination is non-compliant bags (e.g., such as plastic bags or non-compliant bags that are not "certified compostable bags" in the organic stream, or non-transparent bags in the waste stream, etc.), then the surcharge will be based on a set fee per bag (presently \$15.00 per bag). For example, if the load includes 10 plastic bags containing some kind of material, the surcharge billed to the Contractor's account would be 10 x \$15.00 = \$150.00. IWMC reserves the right to reject material in non-compliant bags and have the Contractor remove them from the facility, incurring a reloading charge of \$100.00 in total.

10. INSPECTION, PERIODIC MONITORING, REVIEW MEETINGS

10.1 Periodic Monitoring

- a) IWMC may, at its sole discretion, conduct periodic monitoring of the Contractor's performance for compliance with the requirements of the Work as set forth in the Agreement and this Schedule B. Such periodic monitoring will be conducted by staff of IWMC at locations including, but not limited to, streets and roadways, Serviced Units, and Receiving Facilities.

10.2 Vehicle Inspections

- a) IWMC may, at its sole discretion, conduct periodic vehicle inspections (at least annually) for the items as delineated in the attached Equipment Inspection Report (Appendix B1). Items found to be non-compliant must be promptly corrected by the Contractor as directed by IWMC's Solid Waste Collection Representative.

10.3 Review Meetings

- a) In addition to regular communications, the Contractor shall, at least quarterly, attend regularly scheduled review meetings with IWMC in order to maintain clear and effective lines of communication and to discuss topics including, but not limited to, the Contractor's performance, IWMC's initiatives, the Work, Customer Service and Service Failures.
- b) Such review meetings shall be scheduled by IWMC's Solid Waste Collection Representative and the Contractor shall be provided no less than 10 days' notice of such review meeting and such notice shall include a proposed agenda for the review meeting.
- c) When requested by IWMC, the Contractor's staff involved in Collection under this Agreement (e.g., management, supervisory, administrative, and all front-line personnel including drivers and collectors) shall be made available for such review meetings.

11. CUSTOMER SERVICE AND MISSED COLLECTIONS

11.1 Customer Service

- a) The Contractor shall assist with the provision of effective customer service regarding the progress and performance of the Work in accordance with the following:
 - i. The Contractor shall communicate with IWMC's CSC by:
 - (1) providing courteous, timely and accurate, relevant information to IWMC with respect to the Work, including the Collection and Transportation of Source Separated Solid Waste or Organics so it can be communicated to the residents;
 - (2) providing to IWMC immediately written information which details complaints and other communications from residents concerning any aspect of the Work,
 - (3) responding to IWMC inquiries to assist with the resolution of complaints from Residents;
 - (4) providing educational feedback to Residents through educational tags/stickers affixed to Resident's materials by the Contractor, in accordance with this Schedule B;
 - (5) notifying IWMC immediately when the Work may be or has been interrupted by weather conditions, roadway conditions, equipment malfunctions, or similar delays or disruptions including missed streets (e.g., due to access issues or Contractor error) and provide IWMC with an indication as to revisions to the Work that the Contractor will undertake as a result of the interruption or disruption. For greater clarity, when aspects of the Work have been interrupted or missed, the Contractor shall, as soon as reasonably possible, and, in any case, by no later than 6 p.m. on the same day as when the Work was to be performed, provide a detailed list of missed streets and estimated timelines to recover any missed Source-Separated Solid Waste or Organics to the IWMC Solid Waste Representative;
 - ii. In addition to communicating effectively and efficiently with IWMC as set forth in Section 11.1(a)(i), the Contractor shall also:
 - (1) Ensure vehicles used by the Contractor's supervisory staff, and all of its collection vehicles, are equipped with two-way radios or cellular phones so that communications related to inquiries and complaints can occur and communication of alternatives or changes to the Work may be communicated in real time to the Contractor's employees;
 - (2) Ensure that staff, who are involved in performing the Work, participate in all training/orientation sessions, including, but not limited to, training with respect to Customer Service and training/orientation sessions scheduled by IWMC. IWMC shall

provide no less than 14 days' notice of such training/orientation.

- (3) Adhere to the standards for Customer Service which will be monitored by IWMC and reviewed with the Contractor periodically and during the review meetings as set forth in, respectively, Sections 10.3(a) and (b) of this Schedule B.

11.2 Missed Collections

- a) If it is determined by IWMC that the Contractor failed to collect the Waste, Organics, Spring/Fall Cleanup materials or Christmas Trees in accordance with this Agreement including Schedule B, then the Contractor shall return to the applicable Serviced Units to collect the missed Waste, Organics, Spring/Fall Cleanup Materials or Christmas Trees.

- b) Missed Waste or Organics Carts or Excess Materials:

Residents have up to two working days to report a missed collection. IWMC will maintain customer call records, analyze trends, and evaluate Daily Driver Reports to help determine the validity of missed collection reports. Contractors will be advised by IWMC of valid missed collections and upon notification are expected to return as soon as possible but no later than the end of the second of two working days after the day of the report to provide the collection.

NOTE: When a collection schedule is interrupted due to inclement weather, poor road conditions, weight restrictions, blocked vehicle access, or due to any other circumstance not the fault of the resident, an alternate collection must be provided as per 11.2 (b).

In the event that a collection is delayed due to such circumstance the two day return time limit may be extended. In such cases, the Contractor must notify IWMC with details of the situation and an estimate of when the collection will be completed. IWMC retains the right to approve or reject any extension to the two day return requirement.

- c) Missed Spring/Fall Cleanup Materials:

When a resident reports a missed Spring/Fall Cleanup collection, the process in 11.2(b) shall apply.

- d) Missed Christmas Trees:

When a resident reports a missed Christmas tree collection, the process in 11.2(b) shall apply.

- e) No Education Tag/Sticker Left with Rejected Materials:

In the event that carts/containers/bags/bundles are not collected, and no tag/sticker has been left by the Contractor to advise the resident of the problem, IWMC will consider it a missed collection and the process in section 11.2(b) shall apply.

12. REPORTING REQUIREMENTS

12.1 Daily Drivers Report

- a) The Contractor shall prepare and submit at the end of each collection day a Daily Drivers Report (the “**Daily Drivers Report**”) in the format set forth in Appendix B2 – Drivers Daily Report, which shall include:
 - i. the date and day of the week the Work was performed;
 - ii. the civic address of each Serviced Unit where material was rejected and an education sticker was placed, detailing the type of compliance problem, and the reason(s) materials were not collected;
 - iii. the civic address of a single-family home that has more than one waste or compost cart, along with the serial numbers of the carts;
 - iv. the civic address of businesses which appear to be improperly using a residential waste or compost cart, along with the serial numbers of the carts;
 - v. the civic address (location) where it appears there are abandoned residential waste or compost carts, including the serial numbers of the carts;
 - vi. the civic addresses and serial numbers of damaged carts so they can be repaired or replaced;
- b) Data generated by a Contractor’s AVLT may be used as part of the information requirements to generate the above Daily Driver’s Report information provided the data is presented in a format acceptable to IWMC.
- c) The Daily Driver’s report shall be submitted at the end of each day (i.e., submitted via electronic mail or Fax to the IWMC Customer Service Center).
- d) The Daily Driver’s Report must be submitted using the reporting format approved by IWMC. Alternate reporting, including text messages, is not acceptable.

12.2 General Information

- a) Upon reasonable request by IWMC, which may occur at any time during the Operational Term, or any Extension Term(s) the Contractor shall provide to IWMC the following information:
 - i. Serviced Unit counts for a particular zone and/or Region;
 - ii. The number of collection stops per collection vehicle for a particular collection day;

- iii. The level of participation counts; and
 - iv. any other reasonable information which may from time to time be required by IWMC.
- b) IWMC may choose to collect and retrieve this information by placing its employees within the Contractor's collection vehicles, in which case IWMC will provide the Contractor with no less than 24 hours' notice, and the route involved.

12.3 Incident Reporting

- a) After contacting the appropriate emergency services, as applicable, the Contractor shall immediately report to IWMC any motor vehicle accidents involving the Contractor's collection vehicles, equipment or staff.
- b) The Contractor shall immediately report to IWMC spills of collection vehicle fluids (including, but not limited to, hydraulic fluids, oil, diesel) and to any other authorities in accordance with Applicable Laws. The Contractor shall clean-up such spills promptly and in accordance with best management practices for handling such clean-ups and the requirements of this Agreement, including this Schedule B.

12.4 Monthly and Annual Reporting

- a) In addition to any other record-keeping obligations set forth in the Agreement, including this Schedule B, the Contractor shall maintain the following plans (the "Plans"):
- i. operating plans, including a description of the Contractor's equipment and general operational details;
 - ii. health and safety plan including safety procedures and protocols, which shall include, but not be limited to, the following general topics and activities:
 - (1) the Contractor's health and safety policy;
 - (2) assignment of responsibilities;
 - (3) hazard assessment procedures;
 - (4) driving and moving from the curb;
 - (5) backing, getting on and off the collection vehicle;
 - (6) guiding vehicles;

- (7) manual lifting;
 - (8) loading the vehicle;
 - (9) injury prevention; and,
 - (10) fuelling vehicles,
- iii. emergency response plans for dealing with hazardous waste, fires, explosions, spills and other emergencies which can be reasonably anticipated, setting out procedures, personnel responsible, emergency equipment, notification procedures for proper officials and coordination and emergency communication systems;
 - iv. training plans; and
 - v. contingency plans in the event of disruptions of the Work.
- b) In addition to any other record-keeping obligations set forth in the Agreement, including this Schedule B, the Contractor shall maintain the following records:
- i. types and quantities of Source-Separated Solid Waste and Organics collected and transported; and
- c) The Contractor shall provide IWMC with updates to its plans covered by Section 12.4 (a) that may occur from time to time during the Term or an Extension Term(s);
- d) No later than 10 days after the end of each month during the Term, or an Extension Term(s), the Contractor shall submit a monthly report which includes the following information for the previous month:
- i. motor vehicle accidents and incidents;
 - ii. injuries sustained including number and types of incidents (with no Contractor employee information included);
 - iii. number of lost time incidents and major corrective actions taken; and
 - iv. property damage.

Appendix B1

COLLECTION VEHICLE INSPECTION REPORT		Truck #: Make/Year: Licence #:	
Hauler: _____ Region(s): _____			
Date:			
Time:			
Contract Requirements	(Please circle)		NOTES:
Company Name Affixed to Vehicle	YES	NO	
Telephone Number	YES	NO	
I.D. No. Displayed and where located	YES	NO	
Cleanup Materials			
- Broom	YES	NO	
- Shovel	YES	NO	
- Absorbent Agent	YES	NO	
Cautionary Lights	YES	NO	
Fire Extinguisher	YES	NO	
Special Markings "This Vehicle Makes Frequent Stops"	YES	NO	
Safety Inspection Valid	YES	NO	
Aesthetics paint/rust/clean of dirt			
Vehicle registration matches the licence plate, make, model, colour, VIN			
Lifter: - Type - Cycle Time (10 sec)			
Education Stickers On Board & Daily Log Info.	YES	NO	
NOTES/OBSERVATIONS:			

Inspection by: _____



WASTE WATCH AREA RESIDENTIAL COLLECTION SCHEDULE

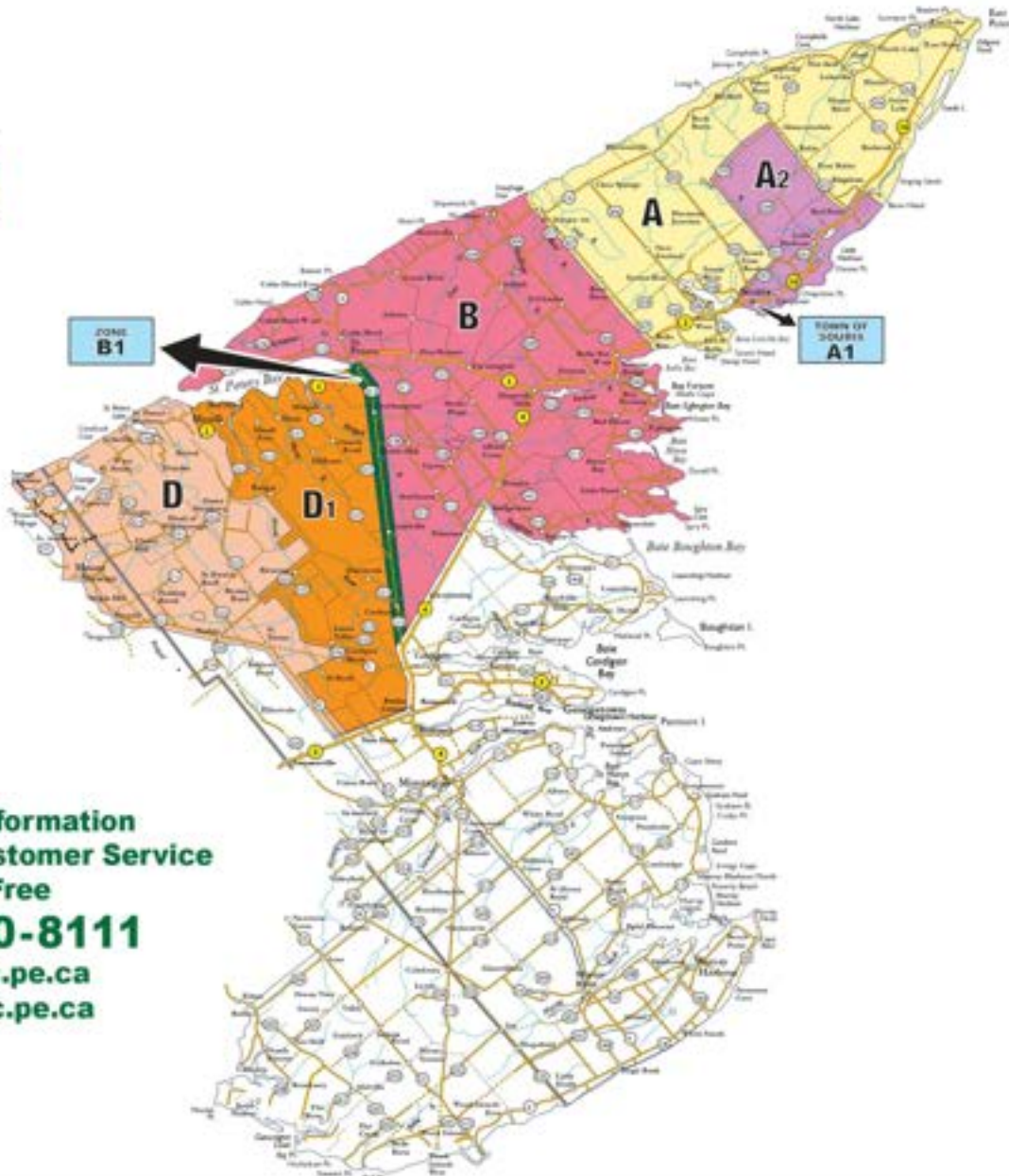

For further information
 please contact Customer Service
 at Toll Free
1-888-280-8111
info@iwmc.pe.ca
www.iwmc.pe.ca

MARCH/2023

COLLECTION DAYS

ZONES	RECYCLABLES	CARTS	ZONES	RECYCLABLES	CARTS
A	3rd Tuesday	Thursday	B1	3rd Wednesday	Monday
A1	2nd Friday	Wednesday	D	3rd Friday	Tuesday
A2	3rd Tuesday	Wednesday	D1	3rd Friday	Monday
B	3rd Wednesday	Friday			

EASTERN KINGS REGION

RECYCLABLES

BLUE BAG #1



USE TRANSPARENT BLUE BAGS ONLY!

- Recyclables must be clean & dry.
- Ensure blue bags are tied securely.

BLUE BAG #2



PLACE THE ITEMS LISTED BELOW BESIDE YOUR BLUE BAGS

PAPER BAGS & CORRUGATED CARDBOARD
(Collapsed & bundled)



LARGE METAL ITEMS

- ✓ bundle multiple items (tent poles, curtain rods, etc.)
- ✓ less than 4 ft & 50 lb
- ✓ dismantle large items
- ✗ no propane cylinders, tanks or items containing ozone-depleting substances (e.g. Freon)

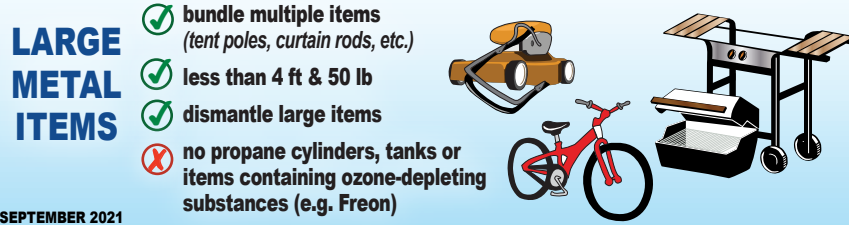

COMPOST



Food Waste (including bones & shells)

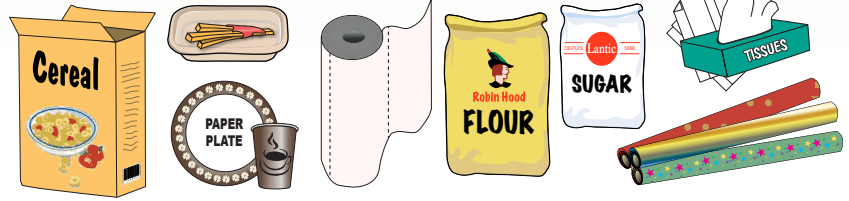

Food-Soiled Paper, Napkins, Paper Towels, Tissues, Paper Food Bags, Wrapping Paper (non-foil/glitter)

TIP: USE EMPTY BOXBOARD TO GATHER KITCHEN SCRAPS



Coffee Grounds and Filters, Tea Bags, Yard & Garden Waste

NO BAG IS BEST!

If bags are necessary:

- ✓ Paper bags are preferred
- ✓ Film compostable bags must be identified by:



✗ DO NOT USE PLASTIC BAGS



**NO Plastic
NO Metal
NO Glass**
IN COMPOST CART

WASTE



Non-Recyclable Plastics with no Symbols or Recycle Symbols

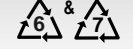

NO BAG IS BEST!

If bags are necessary:

- ✓ Use clear, transparent plastic bags
- ✗ No blue bags
- ✗ No solid-coloured bags
- ✗ No paper bags



DO NOT USE solid-coloured bags

SPECIAL DISPOSAL

NEVER COLLECTED IN CARTS, BLUE BAGS, DUMPSTERS OR DURING SPRING/FALL CLEANUP!!

PROPANE TANKS

30 lb. or less: Propane tank exchange location or WWDC*
 Over 30 lb.: Propane dealer
 Cylinders: WWDC*



For businesses only cylinders are accepted at WWDC and disposal fee applies.

LARGE BULKY FURNITURE

Items larger than 4 ft or heavier than 50 lb are accepted at WWDC* for **FREE** disposal. *Businesses: disposal fee applies*



LARGE APPLIANCES

Bring to WWDC* for **FREE** disposal



TIRES

Return to place of purchase or bring to WWDC*. **Tires without rims are FREE**



PRINTER CARTRIDGES

Accepted at WWDC* for **FREE** and at most electronic retailers. Search *Printer Cartridges* at www.iwmc.pe.ca/sort for more information.



HAZARDOUS WASTE

RESIDENTS: Bring to WWDC* for **FREE** disposal - *Must be in sealed original container. Jerry cans and other containers must be left behind with contents.*

BUSINESSES: Businesses must dispose of hazardous material through a hazardous waste carrier. Visit www.iwmc.pe.ca/commercial for more information.

- fuel (gasoline, kerosene, etc.)
- silicone, caulking, adhesives
- aerosol cans with contents
- cosmetics & personal care products

- pesticides, herbicides, insecticides
- items with mercury
- pet medications
- cleaning products and more



STEWARDSHIP PROGRAMS

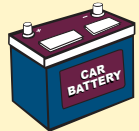

AUTOMOTIVE LEAD ACID BATTERIES

Bring to WWDC* for **FREE** disposal. Also accepted at place of purchase and scrap metal dealers.

LIGHT BULBS



All types of bulbs removed from fixture are accepted for **FREE** at WWDC*. Call in advance for more than 16 bulbs. Visit www.productcare.org for drop-off locations and disposal instructions.

PRESCRIPTIONS, OVER-THE-COUNTER MEDICATIONS AND NATURAL HEALTH SUPPLEMENTS



RESIDENTS: Return to participating pharmacies. For disposal instructions & drop-off locations visit www.healthsteward.ca/returning-medications

BUSINESSES: Search *Medication* at www.iwmc.pe.ca/sort

MEDICAL SHARPS (Needles, Syringes, Lancets, Epi-Pens)



RESIDENTS: Pick up free sharps container at participating pharmacies. When container is full, return to pharmacy. For disposal instructions & drop-off locations visit www.healthsteward.ca/returning-medical-sharps

BUSINESSES: Search *Medical Sharps* at www.iwmc.pe.ca/sort

AUTOMOTIVE FLUIDS (less than 50L container sizes)



Motor oil, oil filters and containers; automotive antifreeze & containers; aerosol cans for propelled lubricant & brake cleaner. Bring to WWDC* for **FREE** disposal or return to collection facilities listed at www.uoma-atlantic.com

PAINT, STAINS AND EMPTY CONTAINERS



Bring to WWDC* for **FREE** disposal, exceptions apply. Visit www.productcare.org for limits, guidelines & additional drop-off locations.



RECHARGEABLE AND NON-RECHARGEABLE BATTERIES

Accepted for **FREE** at WWDC*. Visit www.call2recycle.ca for disposal instructions and additional drop-off locations.

ELECTRICAL AND ELECTRONIC EQUIPMENT AND APPLIANCES

Bring to WWDC* for **FREE** disposal. Call in advance when bringing more than 25 items. For additional drop-off locations visit www.recyclemyelectronics.ca/pei/where-can-i-recycle

- Portable Air-Treatment Appliances (no A/Cs)
- Floor, Garment and Carpet Appliances
- Countertop Appliances
- Personal Care Appliances
- Time & Weight Measurement Devices
- Computers and Computer Accessories
- Phones and Pagers
- TVs and Monitors
- Photocopiers, Printers, Scanners and Multifunction Office Equipment
- Portable, Home and Vehicle Audio/Video Devices and Accessories
- Electronic Readers
- Global Positioning Systems (GPS)
- Video Game Devices and Accessories



For a complete list of items, search *Sorting Guide* at www.iwmc.pe.ca/sort or visit www.recyclemyelectronics.ca/pei/what-can-i-recycle

WASTE WATCH DROP-OFF CENTERS (WWDC)

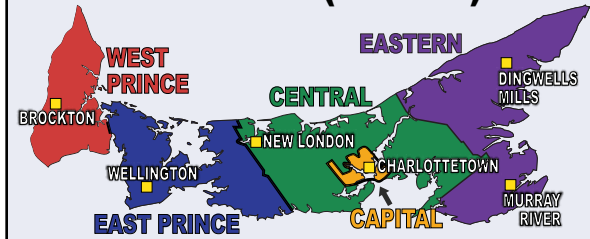

REGION / ADDRESS	SUMMER	WINTER
CAPITAL: GreensIsle, 8 Superior Cr., Charlottetown	7 - 5:30 Mon - Fri; 7 - 2:00 Sat	Same
WEST PRINCE: Brockton, 2202 Dock Rd., Rte. 150	8 - 4:30 Mon, Wed, Fri; 8 - 12:30 Sat	Same
EASTERN: Dingwells Mills, 100 Selkirk Rd., Rte. 309	8 - 4:30 Mon, Wed, Fri; 8 - 12:30 Sat	Same
EASTERN: Murray River, 378 Cape Bear Rd., Rte. 18	8 - 4:30 Tues, Thurs & Sat	Same
EAST PRINCE: East Prince Waste Management Facility Wellington Centre, 29786 Rte. 2	7 - 4:30 Mon - Fri 7 - 12:30 Sat	8 - 4:30 Mon - Fri 8 - 12:30 Sat
CENTRAL: New London, 10142 Route 6	8 - 4:30 Mon, Tues, & Thurs 8 - 2:00 Sat	8 - 4:30 Tues & Thurs 8 - 12:30 Sat

FOR MORE INFO VISIT www.iwmc.pe.ca

REMINDER FOR A WWDC VISIT

We are unable to assist with unloading your vehicle at WWDC. When dropping off heavy materials, please bring along a helper.



ATTACHEMENT 3
Multi-Unit (apartments) List (12 units or more)
See notes below

	# of Properties	# of Buildings on Property	# of Family Units on Property	Total Unit Count
	1	1	14	14
Total	1	1	14	14

Notes:

- 1. This list does NOT include properties with condominium units where each unit has separate ownership.**
- 2. This list includes all styles of multi-unit buildings - multi-level, row housing, etc.**

MODEL: LT-220

ANSI RATING:	ANSI Z 245.60-1996
LIFT TYPE:	CYLINDER
HYDRAULIC FLOW:	2 - 3 GPM
CYCLE TIME:	8-10 SECONDS
MAX. LOAD WEIGHT:	400 LBS (180 KG)
OPTIONS:	TAP-IN-KIT
HYDRAULIC PRESSURE:	WORKING PRESSURE - 1800 PSI - 2100 PSI
CART COMPATIBILITY:	TYPE B CARTS (DOMESTIC STYLE 2-BAR) TYPE C CARTS (EUROPEAN STYLE)

**Compact Extra Long Arm Tipper**

The **C-220** dumps deeper inside the hopper to prevent spillage and dumps higher to reduce the need to cycle the packer blade. Lifts most Domestic and Euro Style 2-wheeled Carts (up to 95 gal. - 360 liters) - accommodates manual loading as well.

- Cylinder-powered Tipper delivers all the performance you need, (up to 800 cycles per shift.)
- Thin profile for mounting on side loaders.
- Lifts most Domestic and Euro Style 2-wheeled Carts (up to 95 gal. - 360 liters) - accommodates manual loading as well.
- Original sweeping action automatically adjusts to varying heights and uneven terrain allowing operators to mount carts securely onto the Tipper lifting hook.
- The C-220 dumps deeper inside the hopper to prevent spillage and dumps higher to reduce the need to cycle the packer blade.
- Cannot be damaged by side loader packer blade.
- Trunnion-mounted cylinder makes for easier mounting.

Specifications are subject to change without any notice or obligation on the part of the manufacturer. While due caution has been exercised in the production of this document, possible errors and omissions are unintentional.



C-220

The **C-220** dumps deeper inside the hopper to prevent spillage and dumps higher to reduce the need to cycle the packer blade. Lifts most Domestic and Euro Style 2-wheeled Carts (up to 95 gal. - 360 liters) - accommodates manual loading as well.

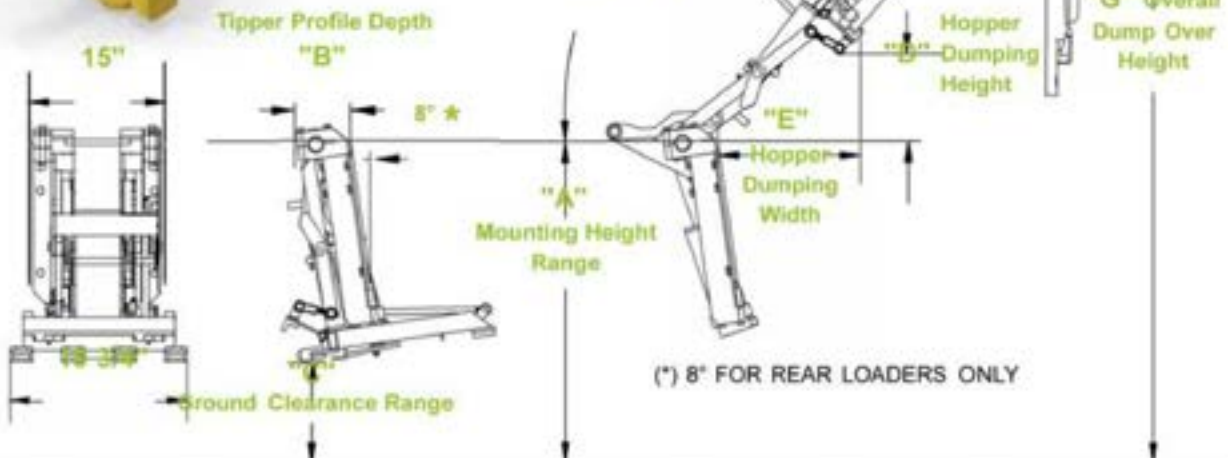

(* 8" FOR REAR LOADERS ONLY

MODEL		"A" DIM.	"B" DIM.	"C" DIM.	"D" DIM.	"E" DIM.	"F" DIM.	"G" DIM.
RT-220	Rear loader	38 - 44"	6"	14" - 18"	9"	16"	45"	97" - 103"
LT-220	Side loader	42 - 47"	6"	16 1/2" - 21 1/2"	9"	19"	50"	101" - 106"
LXT-220	Side loader	42 - 47"	6"	12" - 17"	17"	18"	45"	109 1/2" - 114 1/2"
RE-220	Rear loader	38 - 44"	6"	14" - 18"	9"	16"	45"	97" - 103"
LE-220	Side loader	42 - 47"	6"	16 1/2" - 21 1/2"	9"	19"	50"	101" - 106"
LXE-220	Side loader	42 - 47"	6"	12" - 17"	17"	18"	45"	109 1/2" - 114 1/2"
RA-220	Rear loader	38 - 44"	6"	14" - 18"	9"	16"	45"	97" - 103"
LA-220	Side loader	42 - 47"	6"	16 1/2" - 21 1/2"	9"	19"	50"	101" - 106"
LXA-220	Side loader	42 - 47"	6"	12" - 17"	17"	18"	45"	109 1/2" - 114 1/2"

Dimensions accommodate most ANSI Z245.60-1996 Type B Carts (Domestic Style 2-Bar) and most ANSI Z245.60-1996 Type C Carts (European Style) Containers, but may vary due to container specifications or applications. All dimensions are approximate.



Toll Free: 1-800-711-6188

ATTACHMENT 5

SPRING & FALL CLEANUP

Organics:

Spring and Fall Cleanup collections are scheduled for May and November (usually the first and third weeks).

Spring and Fall Cleanup organic material must be collected on a separate vehicle and not the one used for weekly cart collections.

The collection must begin each week on the Monday and all routes must be completed by Saturday of the same week. Completed routes must be reported at the end of each day to the Customer Service Center (CSC).

Waste:

Spring and Fall Cleanup waste materials are collected during the regularly scheduled waste collection weeks in the months of May and November. Spring and Fall Cleanup waste materials can be collected with the weekly waste cart material.

COLLECTION GUIDELINES:

- ✓ Each item should not exceed a length of four (4) feet for any dimension
- ✓ Each item should not exceed fifty (50) lbs (22 kg)
- ✓ Larger items can be cut/folded to meet these guidelines
- ✓ Multiple items must be bundled (when practical), but the bundle must still meet the guidelines
- ✓ Leaves can be in compost carts, rigid containers or paper bags
- ✓ Waste can be in waste carts, rigid containers or clear plastic bags

ITEMS WHICH WILL NOT BE COLLECTED CURBSIDE

- ✗ Leaves in plastic bags
- ✗ Household hazardous waste (cleaners, pesticides, etc.)
- ✗ Items heavier than fifty (50) lbs (22 kg) or longer than four (4) feet for any dimension
- ✗ Appliances containing Ozone Depleting Substances (Freon, etc.)
- ✗ Tires

- ✘ Stewardship Program Materials (e.g. automotive lead-acid batteries, electronics, paint and stains and empty containers, automotive fluids, empty containers and filters, medications and sharps, light bulbs, rechargeable and non-rechargeable batteries, agricultural plastic products)
- ✘ Propane tanks
- ✘ Items from businesses
- ✘ Large amounts of construction, demolition and renovation (CDR) debris
- ✘ Items that contain more than 50% metal
- ✘ Other items that do not fit the above guidelines

VOLUME GUIDELINES

- ✓ No limit on bags or containers of leaves to be collected during Spring/Fall Cleanup
- ✓ Equivalent volume of ½ ton truck for household waste - approximately 8' (Length) x 4' (Width) and 3' (Height)
- ✓ Equivalent volume of 240 litre cart (material that could be classified as CDR)

REJECTION/EDUCATION

- ✓ Materials not collected must be accompanied by a rejection/education tag or sticker with an explanation as to why it was left. All rejected material must be included on the Daily Driver's Reports, which must be scanned or emailed to the CSC daily.

MISSED COLLECTIONS

- ✓ Missed collections reported to the CSC by residents will be evaluated and those found to be legitimate missed collections by the Contractor will require a return by the Contractor to collect the missed material(s) within the prescribed timeframe as set forth in Section 11.2 (c) of the Work Specification – Schedule B.

Attachment 6 - Backyard Collections (BYC)

Region	Civic Address	Community	Year Round	Cottage	Comments
Eastern Kings	8208 NORTHSIDE RD RTE 16	PRIEST POND	1	-	
	26 MACMILLAN RD	FIVE HOUSES	1	-	
	714 FRENCH VILLAGE RD	FRENCH VILLAGE	1	-	
	158 MACASKILL RIVER RD	GOOSE RIVER	1	-	
	9 SOURIS RIVER RD	SOURIS	1	-	
	996 BANGOR RD RTE 321	BANGOR	1	-	
	833 RTE 2	ROLLO BAY	1	-	
	34 POND ST	SOURIS	1	-	
	5 BLOOMSBURY ST	SOURIS	1	-	
	22 BLOOMSBURY	SOURIS	1	-	
	621 RTE 2	SOURIS WEST	1	-	Winter Months from November-April.
13190 NORTHSIDE RD RTE 16	MONTICELLO	1	-		
Total			12	-	

*unless stated otherwise, BYC collections are provided bi-weekly with regular cart collections year round / seasonally.

Attachment 7 - List of Churches Collected on the Residential Program

Region	Civic Address	Community	Cart sets - Year Round	Cart sets - Seasonal
Eastern Kings				
	3055 EAST POINT RD - RTE 16	KINGSBORO	1	
	11414 NORTHSIDE RD - RTE 16	ST MARGARETS	1	
	14 CHURCH ST	MORELL	1	
	143 Rte 310	FORTUNE BRIDGE	1	
Total Sets of Carts			4	-